

Entrepreneurship Development



Institute of Open and Distance Education

Faculty of Arts

Entrepreneurship Development



1BA2



Dr. C.V. Raman University
Kargi Road, Kota, BILASPUR, (C. G.),
Ph. : +07753-253801, +07753-253872
E-mail : info@cvru.ac.in | Website : www.cvru.ac.in



DR. C.V. RAMAN UNIVERSITY

Chhattisgarh, Bilaspur A STATUTORY UNIVERSITY UNDER SECTION 2(F) OF THE UGC ACT

1BA2
ENTERPRENURSHIP
DEVELOPMENT

1BA2, Entrepreneurship Development

Edition: March 2024

Compiled, reviewed and edited by Subject Expert team of University

1. Dr. Rakesh Gupta

(Associate Professor, Dr. C. V. Raman University)

2. Preeti Shukla

(Associate Professor, Dr. C. V. Raman University)

3. Dr. Shrishti Sharma

(Assistant Professor, Dr. C. V. Raman University)

Warning:

All rights reserved, No part of this publication may be reproduced or transmitted or utilized or stored in any form or by any means now known or hereinafter invented, electronic, digital or mechanical, including photocopying, scanning, recording or by any information storage or retrieval system, without prior written permission from the publisher.

Published by:

Dr. C.V. Raman University

Kargi Road, Kota, Bilaspur, (C. G.),

Ph. +07753-253801, 07753-253872

E-mail: info@cvru.ac.in

Website: www.cvru.ac.in

INDEX

1.	THE CONCEPT OF ENTREPRENEURSHIP	1
2.	THEORY OF ENTREPRENEURSHIP	12
3.	GROWTH OF ENTREPRENEURSHIP	22
4.	NATURE AND IMPORTANCE OF ENTREPRENEURS	28
5.	CLASSIFICATION AND TYPES OF ENTREPRENEURS	46
6.	NATURE AND SCOPE OF MANAGEMENT	56
7.	PLANNING (CONCEPT, PROCESS & TYPES)	73
8.	CONCEPT OF ORGANISATION (SIGNIFICANCE, PROCESS AND NATURE)	81
9.	MOTIVATION	100
10.	LEADERSHIP	119
11.	COMMUNICATION	137
12.	ACCOUNTS FOR SMALL ENTERPRISE	170
13.	ENTREPRENEURSHIP DEVELOPMENT INSTITUTIONS	186
14.	AISECT MODEL OF ENTREPRENEURSHIP	191
15.	HOW TO SET UP AN AISECT CENTRE	201
16.	TRAINING FOR SELF EMPLOYMENT	205

1. THE CONCEPT OF ENTREPRENEURSHIP

1.1 INTRODUCTION TO ENTREPRENEURSHIP

1.2 WHAT IS ENTREPRENEURSHIP

1.3 STIMULATION OF ENTREPRENEURSHIP

1.4 POLICY ENTREPRENEURSHIP

1.5 AN IDEAL ENTREPRENEUR

OBJECTIVE

After this unit you will be able to explain

- Understand the concept of Entrepreneurship.
- Familiarity with Entrepreneurship in developing countries.
- Describe Entrepreneurship stimulation.
- Describe Entrepreneurship & economic growth.
- Describe Entrepreneurship & economic system.

THE CONCEPT OF ENTREPRENEURSHIP

1.1 INTRODUCTION TO ENTREPRENEURSHIP

Entrepreneurship is a process undertaken by an entrepreneur to management his business interests. It is an exercise involving innovation and creativity that will go towards establishing his/her enterprise.

In this chapter, the concept of entrepreneurship and of its related issues are analysed, discussed and deliberated.

One of the qualities of entrepreneurship is the ability to discover an investment opportunity and to organise an enterprise, thereby contributing to real economic growth. It involves taking of risks and making the necessary investments under conditions of uncertainty and innovating, planning, and taking decisions so as to increase production in agriculture, business, industry etc.

Entrepreneurship is a composite skill, the resultant of a mix of many qualities and traits--- these include tangible factors as imagination, readiness to take risks, ability to bring together and put to use other factors of production, capital, labour, land, as also intangible factors such as the ability to mobilise scientific and technological advances.

A practical approach is necessary to implement and manage a project by securing the required licences, approvals and finance from governmental and financial agencies. The personal incentive is to make profits from the successful management of the project. A sense of cost consciousness is even more necessary for the long-term success of the enterprise. However, both are different sides of the same coin. Entrepreneurship lies more in the ability to minimise the use of resources and to put them to maximum advantage. Without an awareness off quality and desire for excellence, Consumex acceptance can not be achieved and sustained. Above all, Entrepreneurship today is the product of team work and the ability to create, build and work as a team. The entrepreneur is the maestro of the business orchestra, wielding his baton to which the band is played.

1.2 WHAT IS ENTREPRENEURSHIP?

Entrepreneurship is the propensity of mind to take calculated risks with confidence to achieve a pre-determined business or industrial

objective. In substance, it is the risk-taking ability of the individual, broadly coupled with correct decision making. When one witnesses a relatively larger number of individuals and that too, generation after generation in a particular community, who engage themselves in the industrial or commercial pursuits and appear to take risks and show enterprise, it is acknowledged to be a commercial class. The commercial class is a myth just like that of the so-called martial race. There are neither, for all time, martial races nor commercial classes. Communities which in the course history once appeared to be martial in spirit have in later period emerged as mercantile societies. Those who were once concerned with and relished in trade, later in history seem to have taken to the profession of these word. Today, it is quite evident to anyone that national communities which have developed world-wide industrial and consequent commercial interests are militarily powerful; nay, great industrial powers have today become super-military powers as well. An enterprise finds manifestation in different ways. The capacity to take risk independently and individually with a view to making profits and seizing an opportunity to make more earnings in the market-oriented economy is the dominant characteristic of modern entrepreneurship. An enterprise, ready for the pursuit of business and responsive to profit by way of producing and/or marketing goods and commodities to meet the expanding and diversifying actual and potential needs and demands of the customers is what constitutes the entrepreneurial stuff.

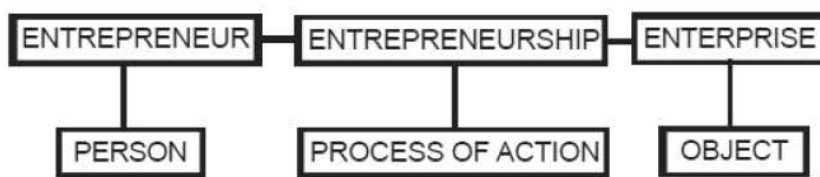

Fig. 1.1 Concept of Entrepreneurship

But this category of enterprising citizens throws up a species of entrepreneurs who are mostly mercantile in outlook and performance. In countries like India, a new species of entrepreneurs is desirable because here the economic progress has to be brought about along with social justice. Entrepreneurship in India therefore, has to sub-serve the national objective. The apparent conflict between social objectives and economic imperatives has to be resolved first by the individual entrepreneur in his own mind and initiate economic growth which includes industrial development as one of the instruments of attaining the social objectives. A high sense of social responsibility is thus an essential attribute of the emerging entrepreneurship in India.

1.3 STIMULATION OF ENTREPRENEURSHIP

Entrepreneurship development is probably one of the most elusive, complicated and perplexing issues in the promotion and growth of

small enterprises. Recently, a number of development agencies have been involved. However, in spite of all these efforts there have been only a few partially successful programmes, and there are many instances of colossal failures in this field.

The stimulation of entrepreneurship is a function of both internal and external variables. The presence of certain personal qualities in an individual is a requisite. Some of the findings about entrepreneurs in Nepal are as follows :

- a. Mainly there are two types of entrepreneurs : The Government and private individuals.
- b. In a family-run business, the entrepreneur is owner as well as manager. Entrepreneurs are frequently found to have parents who were engaged in business-related occupations. Membership in certain types of communities (Newars, Marwadis, Gurung etc.) is highly correlated with entrepreneurship.
- c. Many people who migrated from the hills to the southern part of the country (Terai), and returned have become entrepreneurs.
- d. In the family, a change is taking place. Now the educated young members are becoming entrepreneurs rather than head of the family who generally is old.

1.4 POLICY ENTREPRENEURSHIP

1.4.1 Policy Innovativeness

Availability of Equity or Equity-like funds.

Efforts to assemble public or joint public-private equity funds locally.

Willingness of local developers to risk some of their resources on small or new firms.

Creation of Incubator Facilities for new or young firms.

Availability and nature of small business technical assistance.

1.4.2 Small Business Targeting

Presence of an explicit small business component in the local development organisation.

Amount of staff resources devoted to small firm concerns.

Percentage of capital funds channeled through development organisations into young ventures less than 3 years old.

1.4.3 Policy Commitment

Support of local governmental bodies for economic development.

- Public monies channeled into loan programs.
- Public monies supporting local development organisations.

1.4.4 Characteristics of Public Support

- Level of funding
- Stability and trends in public monies going to development matters
- Year in which programs first used locally

Co-operation of country and municipal officials on economic development.

Working relations between economic developers and elected officials.

Working relations among economic developers.

1.4.5 Early Survey of Entrepreneurship

From the classical economists to the post-Keynesian analysts, the topic of the entrepreneur has been surveyed and observations, theories and pronouncements advances. Not only were pure economists involved in this endeavour but also prominent social theorists such as Marx, Weber, Sombard and Veblen.

In general, contemporary economists agree that the entrepreneur is a business leader and that his role in fostering economic growth and development is a pivotal one. At present, however there is no consensus as to what constitutes the essential activity which makes the entrepreneur a crucial figure. While some economists have identified the basic entrepreneurial function as risk-taking, others have emphasised the co-ordination of production resources, the provision of capital or the introduction of production resources, the provision of capital or the introduction of innovations. Professor James R. Omphers of the International Institute of Entrepreneurship, Honolulu, Hawaii, in his paper entitled "Entrepreneurship, the Critical Factor in National Development", has this to say :

"In all crisis situation, there is one critical factor. There is one factor in each situation that can be cited as being the straw that broke the camel's back! In listing some of today's possible critical factors, such familiar words and phrases limited natural resources.... food....energy all would emerge. A question may be phrased thus: What is the critical factor?!"

Over-population?

Food shortage?

National resources shortage?

Energy shortage?

Lack of technology?

"Many factors have been proposed.... and yet is it possible that the most critical factor has not been recognised? What is this factor that has either been stifled or totally ignored? It is a relatively untapped source... that of qualified individuals with peculiarly unique aptitudes for innovation, for change; aptitudes, in other words, for using present-day technology in ways yet unheard of or perhaps even unthought of. The critical factor is a dire shortage of the appropriate economic innovator and implementor....the Entrepreneurologists."

In the words of A.H. Cole, entrepreneurship is the purposeful activity of an individual or a group of associated individual undertaken to initiate, maintain or organise a profit-oriented business unit for the production or distribution of economic goods and services.

McClelland describes the innovative characteristics of entrepreneurial role. Entrepreneurial role, by definition involves doing things in a new and better way. A businessman who simply behaves in a traditional, way is not an entrepreneur. Moreover, entrepreneurial role calls for decision-making under uncertainty. If there is no significant uncertainty and the action involves applying known and predictable results, then entrepreneurship is not at all involved.

McClelland, like others, identified two characteristics of entrepreneurship. First, doing things in a "new and better way" This is synonymous with the innovative characteristics given by Schumpeter, and secondly, decision-making under uncertainty, i.e., risk as identified by Cantillon. McClelland more explicitly emphasised the need for achievement orientation as the most directly relevant factor for explaining economic behaviour. This motive is defined as tendency to strive for success in situations involved and of one's performance in relation to the same standard of excellence.



Fig. 1.2 Characteristics of Entrepreneurship

In other words, entrepreneurship means the function of creating something new, organising and co-ordinating and undertaking risk and handling economic uncertainty. Higgins defines the term, "Entrepreneurship" as the function of seeing investment and production opportunity, organising and enterprise to undertake a new production process, raising capital, hiring labour, arranging for the supply of raw materials and selecting top managers for the day-to-day operation of the enterprise.

According to Peter Drucker, "Entrepreneurship is neither a science nor an art. It is a practice. It has a knowledge base. Knowledge in entrepreneurship is a means to an end. Indeed, what constitutes knowledge in practice is largely defined by the ends, that is, by the practice."

Innovation and entrepreneurship are thus needed in society as much as in the economy, in public-service institutions as much as in business. It is precisely because innovation and entrepreneurship are not "root and branch" but "one step at a time" a product here, a policy there, a public service yonder; because they are not planned but focused on this opportunity and that need; because they are tentative and will disappear if they do not produce the expected and needed results. In other words, they are pragmatic rather than dogmatic and modest rather than grandiose -- that they promise to keep any society, economy, industry, public service, or business flexible and self-renewing.

Thus, entrepreneurship is a complex phenomenon. "Some think of entrepreneurs primarily as innovators, some chiefly as managers of enterprise, some as bearers of risks, and others place major emphasis on their function as Mobilisers and allocators of capital." In the Indian context, however, an entrepreneur may at best be defined as a person (or a group of persons) responsible for the existence of a new business enterprise.

Entrepreneurship is an attitude of mind which calls for calculated risks; a true entrepreneur is one who can see possibilities in a given situation where others see none and has the patience to work out the idea into a scheme to which financial support can be provided. The stimulation of entrepreneurship is a function of both internal and external variables. In developing countries, there is no dearth of ideas but there is a real scarcity of men with the right blend of vision and practical sense to become successful entrepreneurs. The objective of the programme is to identify such people and to provide them with the support needed to make them a success. They then become "demonstration models" to the community; and once a right climate is generated, entrepreneurship becomes a way of life.

Industrial growth in a country is achieved through a "mix" of the large and small industry; the entrepreneurship for the former comes through the large companies often in collaboration with the multinationals. Simultaneously, economic growth also depends upon the level of development and use of information system in the country.

In fact, the small-scale industry sector is considered as an ideal nursery for the rapid growth and development of entrepreneurship. But alas, there are only a handful of entrepreneurs in the true sense of the term in this sector. The men who will set up small industry units have to come from within the country and the community; they are "locals" in a true sense and their success, therefore, has a much greater impact on generating the right climate for successful entrepreneurship.

Programmes for developing entrepreneurship must recognise that, ultimately, the change they seek to induce is attitudinal - it is more than just providing information, land or money. It is to provide new goals so that a motivated young person is no longer content to take up a secure job which will assure him a modest income but seeks bigger challenges in setting up and running his own business. The risks are greater but so are the rewards both in monetary sense and

psychologically, in the feeling of confidence and pride it generates in the person. It is through the efforts of such persons that a small industry can become a dynamic sector of the economy and hence, the effort made to develop such persons is well worth the investment in terms of labour and cash. The need of the hour is the growth of entrepreneurship to accelerate the process of economic growth. According to Drucker, the entrepreneurial management. In a way, the society needs innovation and entrepreneurship in a normal, steady and on ongoing basis. Just as management has become the specific organ of all contemporary institutions and the integrating organ of our society of organisations, so innovation and entrepreneurship have to become an integral life sustaining activity in our organisations, our economy, our society.

This requires of executives in all institutions to make innovation and entrepreneurship a normal, ongoing, everyday activity, a practice in their own work and in that of their organisation. Entrepreneurship is the cornerstone of the emerging economic scene in the world.

The entrepreneur usually lacks managerial and technical know-how, as well as marketing, production and personnel management skills. These are needed so that even if the entrepreneur can operate on only a small-scale basis, the operation will be economically viable.

Technological advances in the environment create new needs for the entrepreneur as far as adaptation and adjustment are concerned. The entrepreneur may need to learn how to adjust to the new technological environment, or to take a set of advance technologies and bring this to his own level in this sector. Either way, constant re-examination is needed for possible utilisation and improvement of existing technologies.

Finally, the socio-cultural environment also creates a very important climate for the survival of this sector. Small enterprises need the following conditions to keep them alive.

(1) tolerance for changes in the society and culture; (2) social mobility; (3) tolerance of profit making; and (4) tolerance of private ownership.

1.5 AN IDEAL ENTREPRENEUR

An ideal entrepreneur is one who combines values in the market economy; that profits do not somehow preclude ethical behaviour; that growth is possible even if political patronage is not used to bend rules and cut corners, and quite simply that pursuit of wealth can be mannerly one. He takes with him the interest of his people, his country, his natural resources, the ecology and sees that his enterprise becomes a catalytic agent of development. There is thus a need of true entrepreneurs, who do not need incentives, infrastructure, government support; but build their enterprises, harness the resources and develop. They adopt a responsible value-driven corporate philosophy for their enterprises and/or business activities. As such, there is no dispute among economists and social thinkers about the urgent need for the emergence of an

entrepreneurial society as a forerunner of accelerated development of the economy in an integrated manner. The success of an entrepreneur in any enterprise depends on the degree of his vision, leadership, competitiveness, talent, self-reliance, connections, communication and resourcefulness.

Entrepreneurship is not confined to industry and is needed in all activities. Its flowering in agriculture among the cultivators, small and large, is seen by all today. The smiling farm of today in many parts of the country is a proof of such entrepreneurship. The need for entrepreneurship is even greater in management of government, more so as it is the largest entrepreneur.

India has proud record of entrepreneurship. Its present status in the industrial world is its proof. It has now to prepare itself for entrepreneurship of a different order. Tremendous advances of science and technology will have to be harnessed, requiring on the part of the people and the government a more mature and finer approach to match the level reached in the advanced countries. Philips, Sony, Honda, Ford provide the signposts of entrepreneurship today for all to emulate. Some of these have come up only in recent years and from small beginnings. In India, too, one sees glimpses of such entrepreneurship. ICICI's experience tells a great deal about entrepreneurship --good as well as not so good.

CHECK YOUR PROGRESS

1 Write the characteristics entrepreneurship

.....
.....
.....
.....

SMMARY

Entrepreneurship is an attitude of mind which can take risks but calculated ones; a true entrepreneur is one who can see possibilities in a given situation where other see none and has the patience to work out the idea into a scheme to which financial support can be provided. It is one of the catalytic activities fostering initiative, promoting and maintaining economic activities fostering initiative, and distribution of wealth. The stimulation of entrepreneurship is a function of both internal and external variables. In developing countries, there is no dearth of ideas but there is a real scarcity of men with the right blend of vision and practical sense to become successful entrepreneurs. The objective of the programme is to identify such people and to provide them with the support needed to make them a success. They then become "demonstration models" to

the community; and once a right climate is generated, entrepreneurship becomes a way of life.

Industrial growth in a country is achieved through a "mix" of the large and small industry; the entrepreneurship for the former comes through the large companies often in collaboration with the multinationals. Simultaneously, economic growth also depends upon the level of development and use of information system in the country.

In fact, the small-scale industry sector is considered as an ideal nursery for the rapid growth and development of entrepreneurship. But, alas, there are only a handful of entrepreneurs in the true sense of the term in this sector. The men who will set up small industry units have to come from within the country and the community; they are "locals" in a true sense and their success, therefore, has a much greater impact on generating the right climate for successful entrepreneurship.

Programmes for developing entrepreneurship must recognise that ultimately, the change they seek to include is attitudinal; it is more than just providing information, land or money. It is to provide new goals so that a motivated young person is no longer content to take up a secure job which will assure him a modest income but seeks bigger challenges in setting up and running his own business. The risks are greater but so are the rewards, both in monetary sense and psychologically, in the feeling of confidence and pride it generates in the person. It is through the efforts of such persons that a small industry can become such dynamic sector of the economy and, hence, the effort made to develop such persons is well worth the money and labour. The need of the hour is the growth of entrepreneurship in the country to accelerate the process of economic growth. According to Peter Drucker, the entrepreneurial strategy is as important as purposeful innovation and entrepreneurial management. In a way, the society needs innovation and entrepreneurship in a normal, steady and an ongoing basis. Just as management has become the specific organ of all contemporary institutions, and the integrating organ of our society of organisations, so innovation and entrepreneurship have to become an integral life, sustaining activity in our organisations, our economy, our society.

This requires of executives in all institutions to make innovation and entrepreneurship a normal, ongoing everyday activity, a practice in their own work and in that of their organisation.

Entrepreneurship is the cornerstone of the emerging economic scene in the world.

QUESTION

1. What is Entrepreneurship? Explain.
2. What are the characteristics of Entrepreneurship?
3. What are the conditions required by small enterprises to keep them alive?
4. Who is an ideal entrepreneur?
5. What are the various skills needed by an entrepreneur?
6. "Entrepreneurship is an attitude of mind which can take calculated risks but calculated ones". Justify this statement.

2. THEORIES OF ENTREPRENEURSHIP

2.1 ENTREPRENEURSHIP IN DEVELOPING COUNTRIES

2.2 ENTREPRENEURSHIP STIMULATION

2.3 ENTREPRENEURSHIP AND ECONOMIC GROWTH

2.4 ENTREPRENEURSHIP AND ECONOMIC SYSTEM

2.5 THEORIES OF ENTREPRENEURSHIP

OBJECTIVE

- After this unit you will be able to explain
- Describing various theories of Entrepreneurship
- Cyp-1 What is capitalism
- 2 Write a short note on theory of profit

THEORIES OF ENTREPRENEURSHIP

2.1 ENTREPRENEURSHIP IN DEVELOPING COUNTRIES

The concept and theories of entrepreneurship evolved over more than two centuries have undergone major changes. Yet the concept of entrepreneurship is not clear. As the concept of entrepreneurship is complex in its content, it is influenced by not only economical aspects, but also by sociological, political, psychological, ethical, religious and cultural values. The concept also bears testimony to courage, creativity, determination, networking, hard working etc. Over the years the social scientists have interpreted the phenomenon of entrepreneurship differently in accordance with their perception and economic environment.

A co-ordinated and comprehensive theory of entrepreneurship is yet to come. Meanwhile let us understand the important theories of entrepreneurship propounded by social thinkers during the last two centuries.

The distinctive features of entrepreneurship over the years are :

1. Innovation.
2. A function of high achievement,
3. Organisation building,
4. Group level activities,
5. Managerial skills and leadership,
6. Gap filling,
7. Status with draws,
8. Entrepreneurial supply, and
9. Entrepreneurship - an emerging class

Entrepreneurship as a process has and is undergoing changes in keeping with the continued 6 changes in different fields. In keeping with these changes, different theories of entrepreneurship have been evolved by different thinkers at different times. It is a continuously evolving process of change.

Among the many definitions of the entrepreneur, that which distinguishes him as a person who undertakes to organise, manage and assume the risk of running a factory is the one generally adopted in the region. Small enterprises, like entrepreneurship, cannot be defined specifically. The concept is variously understood

in different countries depending on the prevailing economic and social conditions. Generally, the definition is based on two criteria quantitative, which includes the size of the company in terms of number of workers, consumption of energy, capitalisation or value of sales; and qualitative, which refers to the organisation and management of the enterprise, methods of production or influence on the market.

2.3 ENTREPRENEURSHIP STIMULATION

A variety of social, economic, political and cultural factors are stimulating entrepreneurial activity and consequently generating economic development. These stimulants are as follows :

1. An increasing focus on capital formation. Availability of capital is a stimulant to an entrepreneur to start a new firm and/or give birth to a new idea.
2. The ability to transform scientific and technical developments through new institutional development.
3. The supportive government programmes.
4. Availability of required training and inputs.
5. A collaborative relationship between business and research and their direct attempts to transfer technology to the market place will be an opportunity for entrepreneurs who commercialise their ideas.
6. Finally, an endeavour to create an environment conducive to innovation will provide a much-needed stimulant to entrepreneurial activities.

2.3 ENTREPRENEURSHIP AND ECONOMIC GROWTH

Economic development of any region is an outcome of purposeful human activity. Men assume various roles in the development process, namely, as organiser of human capital, natural material resources, worker and consumer. He stands at the centre of the whole process of economic development. According to Schumpeter, economic development consists of "employing resources in a different way", bringing in a new combination of means of production. The entrepreneur looks for ideas and puts them into effect for economic development.

According to Baumol, entrepreneur is a Schumpeterian innovator and something more than a leader. The entrepreneur, according to him, occupies a crucial place in the process of economic development.

Joseph A. Schumpeter (1934) for the first time put the human agent at the centre of the process of economic development and assigned a critical role to entrepreneurship in his theory of economic development. According to Schumpeter "Entrepreneurship is essentially a creative activity or it is an innovative function. The process of innovation may be in the form of (a) Introduction of new product, (b) Use of new method of production, (c) Opening of new market, (d) The conquest of new source of supplying raw material or

(e) A new form of organisation." Hence he depicted an entrepreneur not only a premier agent of production who brings together all factors of production but also provides a sound management and control for the survival as well as the growth of the production unit.

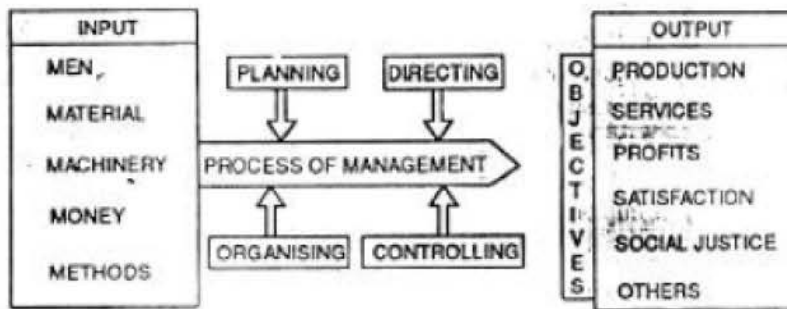

Fig. 2.1

Schumpeter further says that economic growth depends on the rate of applied technical progress (i.e., innovation) and rate of technical progress in the economic field which in turn depends on the supply of entrepreneurs in the society. Thus the entrepreneur is the agent of change in society.

In the Schumpeterian model, entrepreneur is an innovator, and the existence of "innovative entrepreneurs" depends on the necessary social and economic overheads. These economic and social overheads are very poor in backward regions which cause a short supply of entrepreneurs. In this connection, we can refer to David McClelland who explained the development of entrepreneurship in terms of human motivation to achieve or need for achievement (n Ach), His hypothesis is that a society with a generally high level of achievement will produce more energetic entrepreneurs, who in turn will accelerate the process of economic development.

In the Indian context, entrepreneurship has yet another dimension. An entrepreneur may not necessarily be an innovator "but an imitator" who would copy the organisation, technology, products of innovators from other developed regions. His role as an imitator is likely to be guided and controlled by various constraints and conditions peculiar to his area of operation and the factors under which he conducts his minimal modest industrial activity.

Other social scientists, notably Max Weber, have talked of the importance of entrepreneurship and expressed the view that creative and entrepreneurial energies are generated by the adoption of exogeneously supplied beliefs which in turn produce intense efforts in occupational pursuits and accumulation of productive assets leading to the manufacture of goods and service. According to him, entrepreneurs are a product of the particular social conditions in which they live and it is social conditions in which they live and it is the society which shapes the personality of individual entrepreneurs.

John Kunkel believes that the behavioural pattern of individuals is important for development and such a pattern can be influenced by external stimulus so as to alter it in the manner we want it. In other words, if we want more people in society to behave as

entrepreneurs, we can bring about such behaviour on their part by appropriate alterations in the social environment so as to influence them to take to entrepreneurial pursuits. Like Weber, Cocharan and Young underscore the importance of the role society plays in shaping the entrepreneurial personality and consider the scarce ingredients which are essential in the emergence of potential entrepreneurs cultural values, role expectations, social tensions and inter-group relations in society. Entrepreneurs are an important source of economic development. It becomes imperative that there exists a motivational training programme including measures to modify the environment to stimulate entrepreneurial behaviour among individuals. There are thinkers who believe that the "Schumpeterian entrepreneurs are needed in underdeveloped countries for rapid economic development" is only through entrepreneurs that substantial development can be brought about.

2.4 ENTREPRENEURSHIP AND ECONOMIC SYSTEM

Entrepreneurship includes the existence of the spirit of venturing into new enterprises through innovations, creation and translation of such spirit into reality in the various fields of industry and commerce by individuals with entrepreneurial qualities and with an intense desire for accomplishment or achievement in this field.

Entrepreneurship plays an important role in the economic system, which determines the nature and scope of this field. Economic systems grow and take shape under the influence of industrial policy, economic policy, and the socio-political and cultural ideas of the people. Entrepreneurship gives a fillip to new organisational forms and the economy has to adjust to these demands. However, changes in the structure of the economy bring about economic reforms which determine other factors affecting the economy. Economic systems is a basic structure of capitalism, socialism and mixed economy in which a certain level of entrepreneurship is found.

2.4.1 Capitalism

Capitalism has 'freedom' as its landmark. Free enterprise, freedom to save or to invest, free and healthy competition, lack of the dominance of central plan and consumer's sovereignty are the main features that distinguish capitalism from other economic systems. In a free enterprise economy, the problem of what to produce is solved by the price mechanism. The goods are bought and sold in the market at a price which is freely determined by the equality between demand for and supply of goods with reference to the cost of production. It is for this reason that entrepreneurship fully commands a price and market mechanism. On the basis of this, the entrepreneur also has the controls of the production and distribution of goods by mobilising the resources to maximise his profit. Profit motive is the main aim of the entrepreneur in a free market Mechanism under capitalism. He also distributes the goods according to the different market conditions both in domestic and overseas markets and therefore, we find he is a competitor or

monopolist or a monopolistic competitor in the home market, Besides he is a cut-throat competitor in the overseas market where he allocated the amount of goods and determines the price according to his capacity to unload goods - a special case of discriminating monopoly.

2.4.2 Socialism

Private entrepreneurship does not contribute much to an economic system but it becomes the responsibility of the economic and financial experts in the Central Authority to strategise the exploitation of resources and organise an equitable distribution of goods without any profit motive but for the social good.

Entrepreneurship exists in the form of a body consisting of the representatives nominated by the government to frame the plans for the proper mobilisation of resources, their allocation and re-allocation so that most of the resources channalised towards industries of national importance. It is therefore, for entrepreneur who has a complete control over the resources, the production of the goods according to the needs of the people and their distribution in the internal vis-a-vis external market. As socialism is contrary to capitalism or mixed economy, all such responsibilities are not shared by the private entrepreneur and hence his role under socialism is negligible.

2.4.3 Mixed Economy

The entrepreneurs also play an important role in the production and distribution of goods in a mixed economy. The basic characteristics of this economy is that the government undertakes the production of mostly capital goods while the production of consumer goods is left to the private enterprises and hence they are equally responsible for the uplift of the people because they produce not only luxuries and comforts but also goods of basic requirements of the people. Like a capitalist economy, mixed economy also tries to solve the basic problems with the help of the price mechanism. But where the price mechanism fails to achieve the desired result, the state tries to intervene in order to find a better solution to the various problems. When the problem of production is not solved satisfactorily by the private entrepreneur, the state tries to increase the production of essential goods and discourages that of less essential or nonessential goods. It does so by producing defence goods itself as also some basic goods like iron, steel and cement etc. and also by encouraging the private producers to increase the production of essentials like food, clothing, housing etc. In a mixed economy, the government does a good deal to encourage the production of most essential goods and in case their production still lags behind, it may itself undertake their production and increase it by giving it top priority in its economic programme.

In a mixed economy, the government also tries to remove the evil of monopoly capitalism through restrictions. It may curb the growth of monopolies and initiate workable competition which is essential for the optimum use of the available resources.

Mixed economy tries to solve the problem of distribution of goods and services in a better way than the capitalist economy. The government tries to level up the incomes of the poor people and level down those of the rich people. This is done by fiscal measures, fixation of minimum wages and salaries and improvements in the environment by the people.

The role played by an entrepreneur is significantly important in a mixed economy as it permits the growth of both the public and the private sector. In the private sector, profit motive acts as an incentive to the entrepreneur and market mechanism plays its own role. This establishes the role of entrepreneur in the mixed economy.

Entrepreneurship has great importance in various economic systems. It is all the more important under capitalism and mixed economy where not only the responsibilities of entrepreneur in production and distribution are recognised but the objective of growth of business and profit maximisation is also attained. Therefore, the importance of entrepreneurship stands beyond challenge in every economic system except under socialism where it appears in a different form. Yet, entrepreneurship prevails in all economic systems in one form or the other.

CHECK YOUR PROGRESS

1. What is capitalism

.....
.....

2.5 THEORIES OF ENTREPRENEURSHIP

Theories of Entrepreneurship are broadly classified into economic, psychological, sociological and cultural.

The static approach of the emerging Neo-classical school did not readily accommodate a concept with such dynamic connotations as entrepreneur. Alfred Marshall, for example, laid much more stress on the routine activities of management and superintendent than he did on the innovative activity of the entrepreneur.

The phenomenon of entrepreneurship development has been viewed, explained and interpreted differently by social scientists. Among those who have stressed on the routine activities of management and superintendence than he did on the innovative activity of the entrepreneur.

The phenomenon of entrepreneurship development has been viewed, explained and interpreted differently by social scientists. Among those who have stressed on the psychological aspects as contributing to entrepreneurial success are Joseph Schumpeter, McClelland, Hagen and Kunkal.

Entrepreneurship is inhibited by the social system, which denies opportunities for creative facilities : "The forces of custom, the rigidity of status and the district of new ideas and of the exercise of intellectual curiosity, combine to create an atmosphere inimical to

experiment and innovation." The theories of Weber and Cochran in this context are mainly sociological in nature.

Briefly, the concepts of entrepreneur and entrepreneurship have been investigated from economic, social, political, cultural and managerial points. The development of this understanding is summarised in Table 5.1.

2.5.1 Theory of High Achievement

McClelland identified two characteristics of entrepreneurship, namely, doing things in a new and better way and 'decision-making under uncertainty.' He stressed the need for achievement or achievement orientation as the most directly relevant factor for explaining economic behaviour. This motive is defined as the tendency to strive for success in situations involving an evaluation of one's performance in relation to some standard of excellence. People having high need for achievement are more likely to succeed as entrepreneurs. McClelland explains the entrepreneur's interest in profits in terms of a need for achievement. People with high achievement (N-Ach) are not influenced by money rewards as compared to people with low achievement. The latter type are prepared to work harder for money or such other external or such other external incentives. On the contrary, profit is merely a measure of success and competency for people with high achievement need.

2.5.2 Theory of Change

Young conducted the Thematic Appreciation Test (TAT) on a group of entrepreneurs. The test revealed the tendency to describe the situation as a problem to be solved, an awareness of pragmatic effort required, confidence in their own ability to solve the problem and a tendency to take the viewpoint of each individual in turn and analyse the situation as they might see it before suggesting an outcome.

Young's theory is a theory of change based on society's incorporation of reactive subgroups. A group becomes reactive when the following three conditions coincide :

- i. When a group experiences low status recognition
- ii. When denied of access to important social networks; and
- iii. When the group has better institutional resources than other groups in the society at the same level.

2.5.3 Theory of Profit

Knight identifies the entrepreneur as a recipient of pure profit. Pure profit, according to him, with regard to the entrepreneur, is bearing the costs of uncertainty. He identifies uncertainty with a situation where the probabilities of alternative outcomes cannot be determined either by a priori reasoning or by statistical inference. A priori reasoning is simply irrelevant to economic situation involving a unique event.

Knight argues that business uncertainty can be reduced through 'consolidation.' Consolidation is to uncertainty what insurance is to risk; it is a method of reducing total uncertainty by pooling individual instances. The elasticity of the supply of self confidence is the single most important determinant of the level of profit and the number of entrepreneurs.

2.5.4 Theory of adjustment of Price

For Kirzner, the adjustment of price is the main role of the entrepreneur. If the wrong price prevails in the market, then an opportunity for profit is created somewhere in the market if a frustrated buyer or seller is willing, respectively, to pay a higher price or accept a lower one. Then, again, if different prices prevail in the same market, there is scope for profitable arbitrage between the two segments of the market.

According to Kirzner, alertness to disequilibrium is the distinguishing characteristic of an entrepreneur. Alertness enables some individuals to intervene in the market by changing the price while other individuals simply respond by changing their buying and selling plans in lieu of the new price.

Kirzner further maintains that the primary role of economic theory is to explain behaviour in terms of purposeful human action, and to consider to what extent purposeful human actions can interact to produce unexpected outcomes. To pursue the analysis of entrepreneurship further would be to go beyond the limits of the agenda of this piece. Anyone who believes that the entrepreneurs is predictable has an incentive to himself intervene in the market process, and so become an entrepreneur.

To Kirzner, this provides a satisfactory basis for asserting the inherent unpredictability of the entrepreneur. It suggests that no predictor can be anything but an entrepreneur, and so makes a predictive theory of entrepreneurship impossible.

<p>CHECK YOUR PROGRESS</p> <p>2. Write a short note on theory of profit</p> <p>.....</p> <p>.....</p> <p>.....</p> <p>.....</p> <p>.....</p>

SUMMARY

Apart from earning a livelihood and/or making profit, the entrepreneur is also motivated to fulfill his/her innate urge to achieve success in life, improve his/her social standing, gaining social recognition, to provide something to society. The motivational factors vary from place to place, time to time as well as entrepreneur to entrepreneur. Yet motivation moulds the different entrepreneurial traits. The traits and motivation are moulded by the socio, economic, political, cultural and psychological environment and varies from country to country.

The study of entrepreneurial traits and motivation is useful in developing a profile of a successful entrepreneur. It is indeed a positive approach in developing entrepreneurship and enterprise in the country. Although, the entrepreneurial traits are complex, the goal of entrepreneur is to build enterprises to earn profit and serve the society.

QUESTIONS

1. What are the various features of entrepreneurship?
2. What are the various factors which are stimulating the entrepreneurial activity? How do they help in generating economic development?
3. What role does entrepreneurship play in economic system?
4. How mixed economy and entrepreneurs are related to each other?
5. Explain the theory of high achievement.
6. Who propounded the theory of change?
7. What is the theory of profit?
8. On what basis theory of entrepreneurship are classified?

3. GROWTH OF ENTREPRENEURSHIP

3.1 ROLE OF ENTREPRENEURS

3.2 GROWTH OF ENTREPRENEURS

3.3 PROSPECTS FOR ENTREPRENEURSHIP

OBJECTIVE-

After this unit you will be able to explain

- Understand role & growth of Entrepreneurship.
- Understand prospects for Entrepreneurship.

GROWTH OF ENTREPRENEURSHIP

3.1 ROLE OF ENTREPRENEURS

Industrialisation results from the interaction of technological change, specialisation and trade. Good transport, efficient communications, entrepreneurship and an educated labour force help to promote the rapid development of industries. Well defined rules reduced the cost of transactions as specialisation increases and economies become more complex.

A stable institutional framework speed up the process of development. When governments seek to improve the working of markets rather than replace them, the economy generally works better. A rapid and balanced economic development and expansion of opportunities for employment as well as self-employment are the basic objectives of developmental planning. Economic development is primarily related to the impulse of social change reflecting the developmental urge for self-respect, self-help and self-reliance. Underdevelopment or underdevelopment is primarily due to the lack of such an impulse.

The rate of development appears to be directly proportionate to the intensity of the social impulse of change, displayed qualitatively in some sections, marking a departure from the traditional behaviour and conventional occupational pattern which may be called social mobility. Where the social impulse has emerged, the first hurdle in the march of economic progress is overcome. The next task is to see that the impulse is sustained, if not quickened. Where it is conspicuously absent, efforts should be concentrated for its emergence. This demands conscious and massive efforts on the part of leaders of society in virtually all walks of life. A force must set in, so that new techniques of production and correspondingly different types of institutions will make their appearance.

The process of re-structurisation of economy and the society must give a visible evidence. The society in a country must shed inertia and pulsate with a new vigour and urge. Self-reliance, enterprise, innovation and attitudinal change are the attributes of a development-oriented society. These propensities need cultivation, if economic growth is to become a reality. Basically, the task is to change the stratified socio-economic structure in the underdeveloped regions. This can only be achieved if a change is brought about in social of underdeveloped area; shedding lethargy,

apathy and traditional psychology. Further, a new industrial culture has to emerge in the backward regions, reflecting the urge and willingness to observe the industrial discipline and readiness to seek self-employment and gainful employment opportunities.

Entrepreneurs, on the other hand as Schumpeter and many others have already pointed out, are distinct from business owners and managers. They are essentially strategic innovators, seeking profitability with growth. Promoting entrepreneurship, in that sense, is intrinsically different from promoting small-scale industries.

If small business in the developed countries has received special attention it is due to innovation and creativity. Studies have shown that a large number of innovations have come from small rather than large, business. As these innovative firms entered the market they made profits and created jobs. In the U.S. Presidents Jimmy Carter and Gerald Ford emphasised that small business created 60 percent of new jobs there. And this employment generation was due to its better financial performance. Similarly, the Bolton Committee, 1971, and the Wilson Committee, 1979, also concluded that the small business in the U.K. had higher profitability than large business.

The studies on entrepreneurship also point out that, "most of the risk in entrepreneurial management lies not in misperception of opportunity, but in trying to pursue opportunity without adequate resources. One of the fundamental errors of large corporations, on the other hand, is overcommitment of resources."

3.2 GROWTH OF ENTREPRENEURS

In terms of benefiting the people, the development of small and medium-scale industries and businesses offered many advantages. Most important perhaps, amid the mounting unemployment, are the small and medium enterprises which generate more jobs and often use labour-intensive methods of production. Industries and businesses of smaller size also work towards promoting better income distribution and development of entrepreneurship in addition to broader benefits as rural industrialisation and increased export earnings.

One of the most potentially profitable areas of human resources development for small and medium-sized enterprises is the training of entrepreneurs and managers. Such training programmes should be as well rounded as possible, covering not only the basics of business, technology and so forth but also helping the trainees to identify their aptitudes, motivating them, encouraging innovative thinking and helping to develop personalities and attitudes geared for success. Indeed, small industries and business are ideally suited for capitalising on entrepreneurial skills, initiative and talent and thus assisting in building a dynamic private sector in developing countries.

The growth of entrepreneurship in the post-planning period has been significant. For example, between 1960 and 1995 the number of private companies went up from 26,000 to nearly 3,25,200. It will be seen that the maximum increase in the number of factories was

in the case of industries which by virtue of their being in the small/medium-scale sector are less regulated than others. The increase in the number of factories in industries like tobacco and related products, wood and wood products, rubber and rubber products, jewellery, photographic and optical goods, watches and clothes, medical, surgical and scientific equipments, sports equipments, cold storage, etc. was more than forty times during the period 1959-1995.

The growth in the number of small entrepreneurs has been encouraging. The small-scale sector has grown in volume from 16,000 units in 1950 to over 26 lakh units by the end of 1995. The range of items produced by the small scale sector ranges from consumer good to high precision items.

Not only has the number of entrepreneurs grown over a period of time but also the scope of entrepreneurship is getting broad-based. Earlier for a large proportion of firms in India, the basic unit of entrepreneurship was the extended family. This tendency is now getting diluted. A study conducted a few years back by the Economic and Scientific Research Foundation (ESRF) indicates that out of a sample of entrepreneurs studied by them, around 1/5 of them were managers and engineers before they turned entrepreneurs. It was found that around 57 percent of the new entrepreneurs in starting small-scale units were motivated by the experience that they had gained from the previous employment. Entrepreneurship in these cases was not necessarily in-born but largely acquired.

Though impressive in certain ways, the development accomplished so far, as indicated before, is inadequate and far from satisfactory when set against the needs as also the existing vast potential. In fact, according to Prof. Herbert Giersh, a noted economist, there is no shortage of entrepreneurial talent anywhere in the world, but the actual numbers depend on the demand conditions, i.e., the demand permitted, induced or actively provoked by the socio-economic structure and the politico-economic environment. According to him, a mixed capitalistic economy such as ours offers scope for development of entrepreneurial talent not only in the private sector but also in the government sector. The main disadvantage is that bureaucracy tends to limit the scope for entrepreneurial activity in the private sector.

3.3 PROSPECTS FOR ENTREPRENEURS

With the buoyancy achieved in the industrial production as evidenced by the increase in the rate of growth during the current Plan period, expectations of better capacity utilisation and a favourable investment climate reflected in the response of the capital market to the various issues, the prospects of the industrial sector during the Eight Plan period are quite encouraging. The availability of sufficient inevitable resources, development of financial services and the optimism engendered in the export sector and also in the private investors at large would help the industrial sector to move to a higher growth path.

A combination of fiscal and credit policy measures, growth centred programmes recently launched for industrial development, rationalisation of import duty structure on capital goods and

measures of technology upgradation and excise duty relief for weak but potentially viable sick units will give further fillip to the country's industrial development. The Government of India has signed Memoranda of Understanding with important public sector undertaking so as to ensure that the performance targets envisaged are achieved.

Promotion of savings and industrial investment through new saving schemes, creation of new intermediaries and extension of fiscal concession were important measures incorporated in the Budget of 1995-96. Removal of Section 115(I) of the Income-tax Act and reduction in corporate tax rate are expected to have a favourable impact on corporate profitability. Withdrawal of investment allowance is expected to contribute to a more efficient use of capital. Policy measures were announced in May 1990 to further stimulate industrial investment. With these developments and looking to investment proposals in the pipeline, institutions seemed optimistic about the growth prospects. While the pressure on balance of payments continues to cause concern, the economy can be expected to sustain the tempo of growth in the coming year in the context of buoyancy in the key sectors. With this optimism, reflected in their pipeline cases as well, the financial institutions look forward to yet another year of growth.

CHECK YOUR PROGRESS

1. Write a note on growth of entrepreneurship

.....
.....
.....
.....
.....

SUMMARY

As industrialisation is important, organisations and society must develop entrepreneurs, intrapreneurs, managers and skilled workers. Their skills should be sharpened as they live in a competitive world. It is important to develop sound institutions to sustain and broad-base entrepreneurship. The individual's ability to perceive opportunities inherent in change and succeed is founded on the knowledge of products and markets. The entrepreneur has to have a better idea of a product or service and/or a better way to deliver that product or service to a paying customer. If we wish to respond to the new economic and technological environment, we should recast our educational system, broad-base the institutional infrastructure and provide the much-needed support through a single window in each district, taluka or even a town with

development potential for Entrepreneurship is more than a word, it is a mission. Rapid industrialisation needs full support from all concerned to bring about economic progress.

Entrepreneurship has opened avenues of great scope in the Indian economy. Our national economy is most suited to the growth of small business enterprise. Small business units offer a more convenient means of nurturing and developing entrepreneurship by providing the means of entry into business for new entrepreneurial talents. It is a breeding ground for the first generation entrepreneurs.

Small business units provide enormous opportunities to the entrepreneurs in different sectors of the national economy. An entrepreneur can start a new venture in the industrial, agricultural or service sector. Small business sector is by far, the most important sector of the national economy which accounts for about 55 per cent of the total industry production in the country. This sector provided enormous opportunities to the new entrepreneurs.

It holds a key to success in the prevailing socio-economic environment.

Small-scale industries are labour-intensive and can play an important role in solving the problem of unemployment. These industries provide industrial experience and serve as a training ground for a large number of entrepreneurs.

QUESTIONS

1. "A stable institutional framework speed up the process of development". Explain.
2. What are the advantages offered by the small and medium scale industries to the people?
3. What are future prospects for the growth of entrepreneurs?

4. NATURE AND IMPORTANCE OF ENTREPRENEURS

4.1 ENTREPRENEURIAL QUALITIES

4.2 ENTREPRENEURIAL FUNCTIONS

4.3 ENTREPRENEUR VS ENTREPRENEURSHIP

4.4 OPPORTUNITY MATRIX

4.5 ENTREPRENEURIAL DECISION

4.6 ROLE OF ENTREPRENEURS

4.7 GROWTH OF ENTREPRENEURS

OBJECTIVE

After this unit you will be able to explain

- Know about Entrepreneurship qualities & function.
- Distinguish between Entrepreneurship & entrepreneurs.
- Understand opportunity matrix.

NATURE AND IMPORTANCE OF ENTREPRENEURS**4.1 ENTREPRENEURIAL QUALITIES**

The world is rapidly changing; we should be able to change our attitudes and approaches to prevent a country of India's size and potential to exist on the periphery of the world's economy. The process of development includes creation of appropriate infrastructure and setting up and management of public utilities. Non-conventional energy sources have to be developed on a commercial scale. Similarly, application of modern scientific techniques in agriculture and horticulture has become imperative for providing a sound base for a more rapid growth of employment and incomes. There is also a need for rapid growth of distributed industries in a multi-directional way. Apart from land, labour and capital, there is greater need for entrepreneurs to strive for growth on an ongoing basis. In this context an attempt has been made in this chapter to analyse the nature and importance of entrepreneurs.

The entrepreneurial qualities are to some extent innate. But not all of them are entirely innate. Some can be enhanced by training, or simply by experience. For example, analytical ability and computational skill can be enhanced by education at school and university, while practical knowledge and foresight skills can be enhanced by the general experience of everyday life. Entrepreneurial careers will be strongly influenced by the desire to enhance qualities which are scarce, yet difficult to obtain through delegation because of the problems involved in screening for them. Of the two indispensable qualities of the entrepreneur, imagination is almost entirely innate, while foresight, can be enhanced by a varied experience. Imagination and foresight are the scarce qualities which are difficult to analyse and quantify. Delegation skill and organisation skill, though not essential, are highly desirable whenever large-scale decision-making is involved. These are qualities which can be enhanced through experience.

4.2 ENTREPRENEURIAL FUNCTIONS

A successful entrepreneur recognises the commercial potential of a product or service, design operating policies in marketing, production, product development and the organisational structure.

He carries out the whole set of activities of the business. He has a high capacity for taking calculated risks and has faith in his own capabilities.

According to some economists, the functions of an entrepreneur incorporate coordination of the business management of the enterprise, risk-taking, controlling the enterprise, innovation for change, motivation and other related activities. In reality, an entrepreneur has to carry out a combination of these in deeping with time and environment. Truly, he has to consider new ideas, demands and exploit the opportunities, and thereby contribute to technical progress. He is thus a nucleus of high growth of the enterprise.

An entrepreneur is expected to perform the following funtions :

4.2.1 Assumption of Risk

The entrepreneur assumes all possible risks of business. which emerges due to the possibility of changes in the tastes of consumers, techniques of production and new inventions. Such risks are not insurable. If they meterialise, the entrepreneur has to bear the loss himself. Thus, risk-bearing or uncertainty-bearing still remains the most important function of an entrepreneur which he tries to reduce by his initiative, skill and good judgment.

4.2.2 Business Decisions

The entrepreneur has to decide the nature and type of goods to be produced. He enters the particular industry which offers him the best prospects and produced whatever commodities he thinks will pay him the most and employs those methods of production which seem to him the most profitable. He effects suitable changes in the size of the business, its location, techniques of production and does everything that is needed for the development of his business.

4.2.3 Managerial Functions

The entrepreneur performs the managerial function though they are different from entrepreneurial functions. He formulates production plans, sees to the finance, deals with purchase of raw materials, provides production facilities, organises sales includng management. In a large establishment, these management functions are delegated to the paid managerial personnel.

The entrepreneurial functions can be performed by different categories of people under different economic systems. In principle, the entrepreneur could be a planner in a socialist economy, or even a priest or king in a traditional society. In practice, entrepreneurship is closely identified with private enterprise in a market economy.

An entrepreneur performs many useful functions. He undertakes a venture, assumes risk and earns profit. He is the man having a

strong motivation to achieve success. He is self-confident in his entrepreneurial abilities. He exploits opportunities wherever and whenever they arise.

The entrepreneur can identify opportunities to start a business either as a manufacturer or as distributors, for entrepreneurship exists in every field of economic endeavour. Manufacturing activities require a relatively high capital investment and a greater degree of entrepreneurial abilities than distribution activities. Entrepreneurship has also been developed in the trading sector. Britain, for example, has developed trading entrepreneurship while Germany and Japan have developed industrial entrepreneurship. A manufacturing entrepreneur demonstrates his entrepreneurial talents by bringing out new products while a trading entrepreneur performs his entrepreneurial functions in creating demand for the business in which he deals.

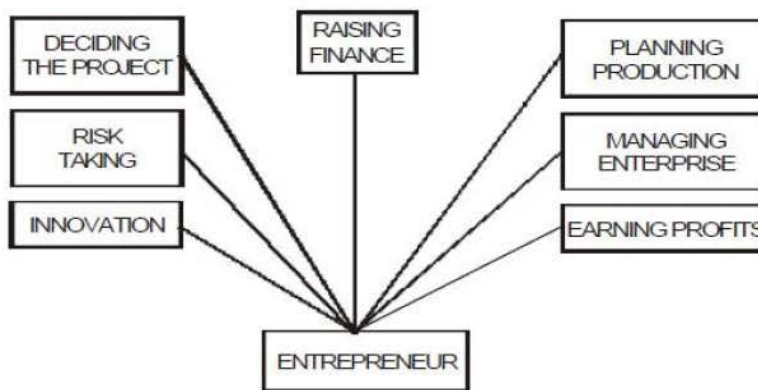

Fig. 4.1 Entrepreneurial Functions

4.2.4 Decision-maker

Arther H. Cole described an entrepreneur as a decision-maker and attributed the following functions to him :

- The determination of those objective of the enterprise and the change of those objectives as conditions required or made advantageous;
- The development of an organisation, including efficient relations with subordinates and all employees;
- Securing adequate financial resources, and maintaining good relations with the existing and potential investors;
- The requisition of efficient technological equipment and the revision of it as new machinery appeared;
- The development of a market for the products and the devising of new products to meet or anticipate consumer's demand; and
- The maintenance of good relations with public authorities and with the society at large.

Modern writers on this subject have outlined the following three broad functions of an entrepreneur :

- Innovation,

- Risk-taking, and
- Organisation and management of business so as to have leadership and control over it.

Innovation means " doing new things or the doing of things that are already being done in a new way." It includes new processes of production, introduction of new products, creation of new markets, discovery of a new and better form of industrial organisation. Risk-bearing means making provisions for capital in order to enable the entrepreneur is to reduce uncertainty in his plan of investment and expansion of the enterprise. Thus innovations may occur in the following forms :

- Introduction of a new good, that is, one which consumers are not yet familiar with or of a new quality of a good.
- Introduction of a new method of production, that is one not yet tested by experience in the concerned unit of manufacture, which needs to be founded upon a discovery scientifically new and which can also exist in a new way of handling a community commercially.
- Opening of a new market, that is, a market into which the particular branch of manufacture of the country in question has not previously entered, irrespective of whether or not this market has existed before.
- Turn into good account a new source of supply of raw material or half-manufactured goods, irrespective of whether this source already exists or whether it has first to be created.
- Carrying out of the new organisation of any industry, like the creation of a monopoly position (for example, through trustification) or the breaking of a monopoly position.

Before coming to other functions, it is necessary to clarify how innovation differs from the two other notions with which it is sometimes confused : research and invention.

The aim of research is to produce knowledge, that of innovation to produce objects which are practical and can be sold. Since it is inspired by different objectives, innovation can be completely independent of research. It is not based on the same skills. Even the relevant information required on markets, on patents and on management has little to do with research. Innovation may be based on the application of knowledge produced by research but it may also be purely empirical : indeed practice often precedes theory and innovation may open the way to research (the steam engine for thermodynamics, or the computer for programming). Moreover, many innovations are not based on research but on ingenious combinations of existing materials and components.

Invention too is different from innovation. An invention becomes an innovation only when it is embodied in a product which can be successfully marketed. History abounds in examples of bankrupt inventors whose brainchild projects took hold year later. The

innovator, on the other hand, is the person who comes on the scene at the right moment to find the missing elements in an invention which will make it eminently marketable. Thus it is always difficult to identify the true innovator. Several individuals or organisations may simultaneously claim the authorship of ideas or inventions which have given rise to innovation.

Innovation cannot be confined to a simplistic scheme. Facts show that small and medium firms, at least in some countries, can make a very significant contribution to technical prosperity. For instance, it is estimated that firms of less than 1000 workers and individual inventors were responsible for more than 40 percent of the major innovations appearing in the United States in the early 1970s. This innovation potential can be explained by the advantages enjoyed by small firms over large ones.

It is now well recognised that entrepreneurs can be rooted out through appropriately designed entrepreneurship development programmes which envisages the approach: developing achievement motivation and sharpening of entrepreneurial traits, four strategies-project planning and development and guidance on industrial opportunities, incentives and facilities and rules and regulations, and developing managerial and operating capabilities. Various techniques and approaches have been developed and adopted to achieve these objectives, keeping in view the target-groups and/or target area. The structuring of the programmes and training methodology also necessitate consideration of the specific target-groups and target area. Methodology for selection of the prospective entrepreneurs as well as support services after training have a significant impact on the success of the entrepreneurs development programmes.

CHECK YOUR PROGRESS

1. Write entrepreneurial qualities

.....

.....

.....

.....

.....

4.3 THE TERM ENTREPRENEUR VS. ENTREPRENEURSHIP

The term Entrepreneur vs. Entrepreneur is often used interchangeably with "entrepreneurship." But, conceptually, they are different, yet they are just like the two sides of a coin. Their differences are as follows :

NATURE AND
IMPORTANCE OF
ENTREPRENEURSHIP

Entrepreneur	Entrepreneurship
Refers to a Person	Refers to a process
Visualiser	Vision
Creator	Creation
Organiser	Organisation
Innovator	Innovation
Technician	Technology
Initiator	Initiative
Decision-maker	Decision
Planner	Planning
Leader	Leadership
Motivator	Motivation
Programmer	Action
Risk-taker	Risk-taking
Communicator	Communication
Administrator	Administration

Entrepreneurship Management is basically concerned with the development and co-ordination of entrepreneurial functions. In a way, entrepreneur precedes entrepreneurship.

Experience shows that entrepreneurship as an economic function is not a single point but rather a range of behaviour. There are six critical dimensions that distinguish entrepreneurial behaviour from more administratively-oriented behaviour : (1) strategic orientation; (2) commitment to opportunity; (3) the resource commitment process; (4) the concept of control over resources; (5) the concept of management; and (6) compensation policy.

		Desired future state involves growth or change	
		Yes	No
Self-perceived power to achieve goal	Yes	Entrepreneur	Satisfied Manager
	No	Frustrated Potential entrepreneur	Bureaucratic functionary

Fig. 4.2 Manager's opportunity Matrix

4.4 OPPORTUNITY MATRIX

A matrix defining entrepreneurship is shown in above fig. one can see how the present position influences whether one is entrepreneurial or not. It stands clear that particular skills, talents, and attitudes towards risk influence the perception as to whether an outcome is feasible. Training, knowledge, and self-confidence contribute to such perceptions.

The importance of this figure cannot be overemphasized since individuals place themselves in their particular box for rational

reasons relating to their own lives; however, for the firms desiring to build the entrepreneurial spirit, action is required.

4.5 ENTREPRENEURIAL DECISION

Entrepreneurial decisions occur despite recession, inflation, high interest rates, lack of infrastructure, economics uncertainty etc. Each of these decisions is a personal human process, which although unique, has some common characteristics. The impulsive motive to change his/her life style and create something new and an inner urge to do something worthy are the forces behind these decisions. At times, perhaps even more stimulation for change comes from a negative force - disruption. At times, the available opportunities force a decision on individuals to take up entrepreneurial work. Like all processes, it entails movement from something non-existent to something new.

What causes this change in the work environment of disruption to result in a new company being formed instead of something else? The decision to start of new company occurs when an individual perceives that it is both desirable and possible.

The perception that starting a new company is desirable results from an individual's culture, sub-culture, teachers, family, and peers. A culture that values an individual who successfully creates a new business will spawn more company formations than one that does not. For example, India's economic scene places a high value on being your own boss, individual opportunity, being a success, and making money - all aspects of entrepreneurship. What is more, many different sub-cultures that shape value system are operating within a cultural framework which support and even promote entrepreneurship.

4.6 ROLE OF ENTREPRENEURS

Entrepreneurs, on the other hand, as Schumpeter and many others have pointed out, are distinct from business owners and managers. They are essentially strategic innovators, seeking profitability with growth. Promoting entrepreneurship, in that sense, is intrinsically different from promoting small-scale industry.

If small business in the developed countries has received special attention it is because it has been the fountain-head of innovation and creativity. Studies have brought out that a large number of innovations have come from small, rather than large business. As these innovative firms entered the market they made profits and created jobs. In the U.S. Presidents Jimmy Carter and Gerald Ford emphasised that small business created 60 percent of the new jobs in the United States. And this employment generation was due to its better financial performance. Similarly, the Bolton Committee, 1971 and the Wilson Committee, 1979, also concluded that the small business in the U.K. had higher profitability than larger business.

The studies on entrepreneurship also point out that, "most of the risk in entrepreneurial management lies not in misperception of opportunity, but in trying to pursue opportunity, without adequate

resources. One of the fundamental errors of large corporations, on the other hand, is overcommitment of resources".

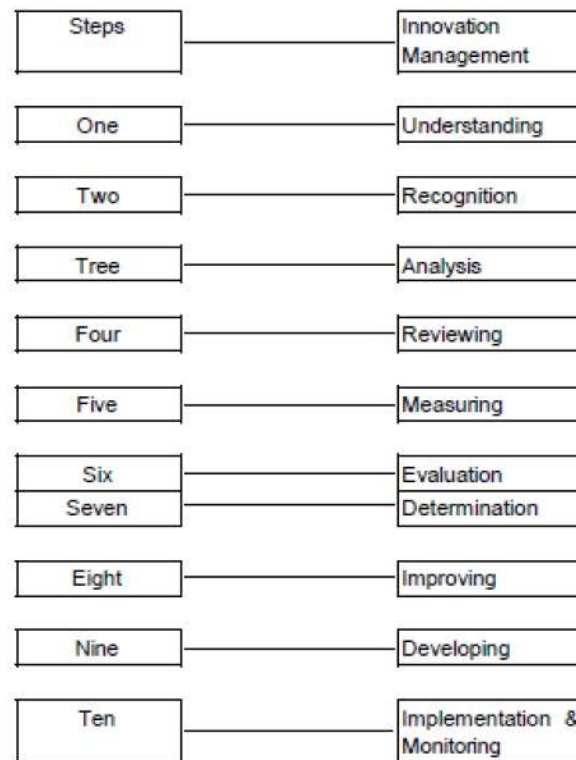

Fig. 4.3 Ten Commandments of Improved Innovation Management

4.7 GROWTH OF ENTREPRENEURS

In terms of benefiting the people, the development of small and medium-scale industries and business offered many advantages. Most important perhaps, amid the mounting unemployment, are the small and medium enterprises which generate more jobs and often use labour-intensive methods of production. Industries and business of smaller size also promote better income distribution and development of entrepreneurship and general skills, in addition to such broader benefits as rural industrialisation and increased export earnings.

One of the most potentially fruitful area of human resources development for small and medium-sized enterprises is the training of entrepreneurs and managers. Such training programmes should be as well rounded as possible, covering not only the basic of business, technology and so forth but also helping the trainees to identify their aptitudes, motivating term, encouraging innovative thinking and helping to develop personalities and attitudes geared for success. Indeed, small industries and business are ideally suited for capitalising on entrepreneurial skill initiative and talent and thus assisting in building a dynamic private sector in the developing countries.

The growth of entrepreneurship in the post-planning period has been significant. For example, between 1960 and 1989, the number

of private companies went up from 26,000 to nearly 1,05,200. It will be seen that the maximum increase in the number of factories was in the case of industries which by virtue of their being in the small/medium-scale sector are less regulated than others. The increase in the number of factories in industries like tobacco and related products, wood and wood products, rubber and rubber products, jewellery, photographic and optical goods, watches and clothes, medical surgical and scientific equipments, sports equipments, cold storage, etc, was more than thirty times during the period 1959-1989.

The growth in the number of small entrepreneurs has been encouraging. The small-scale sector has grown in volume from 16,000 units in 1950 to over 18 lakh units by the end of 1989. The range of items produced by the small-scale sector ranges from consumer goods to high precision items.

Not only has the number of entrepreneurs grown over a period of time but also the scope of entrepreneurship is getting broad-based. Earlier for a large proportion of firm in India, the basic unit of entrepreneurship was the extended family. This tendency is now getting diluted. A study conducted a few years back by the Economic and scientific Research Foundation (ESRF) indicates that out of a sample of entrepreneurs studied by them, around 1/5 of them were managers and engineers before they turned entrepreneurs. It was found that around 57 percent of the new entrepreneurs in starting small-scale units were motivated by the experience that they had gained from the previous employment. Entrepreneurship in these cases was not necessarily in-born but largely acquired and forced upon.

Though impressive in certain ways, the development accomplished so far, as indicated before, is inadequate and far from satisfactory when set against the needs as also the existing vast potential. In fact, according to Prof. Herbert Gieresh, a noted economist, there is no shortage of entrepreneurial talent anywhere in the world, but the actual numbers depend on the demand conditions, i.e., the demand permitted, induced or actively provoked by the socio-economic structure and the politicoeconomic environment. According to him, a mixed capitalistic economy such as ours offers scope for development of entrepreneurial talent not only in the private sector but also in the government sector. The main disadvantage is that bureaucracy tends to limit the scope for entrepreneurial activity in the private sector.

4.7.1 Environment for Entrepreneurship

The entrepreneurs do not come spontaneously of their own. While the other factors of production are at least, in principle, hireable but enterprise is not. They have to come from different vocations. Even the educational system in most of the developing countries is

designed in such a way as to create more of job-creators. In many countries, to sum up, entrepreneurs appear to have been motivated by a combination and interaction of the following factors of environment :

1. Socio-economic environment;
2. Family background;
3. Standard of education and technical knowledge;
4. Financial stability;
5. Political stability and government's policy.
6. Caste and religious affiliation;
7. Availability of supporting facilities;
8. Achievement motivation; and
9. Personality and personal skill.

The environmental factors may be summarized as follows :

1. Entrepreneurship is not influenced by a single factor but is the outcome of the interaction combination of various environmental factors.
2. By changing the environment, society can be recreated.
3. It is the "desire to make money" that drives one to start an industry rather than the amount of money one owns.
4. Encouraging government policy and social recognition influence a person to become an entrepreneur. As an educationist, we can think of modifying the educational system so as to produce more job-creators rather than job-seekers.

4.7.2 Entrepreneurial Initiative

Recent data on entrepreneurial initiative and self-employment reflect a few problems. To overcome these problems to develop entrepreneurial skills. More importantly, the entrepreneur has to initiate the process of development overcoming the barriers. It is itself a challenging task. This unprecedented, perpetual change with unlimited barriers makes entrepreneurial initiative in the future more significant and infinitely, more dynamic.

The message is that stimulating entrepreneurial initiative is strategic process that embodies calculated strategic choices. There are strategies open to the entrepreneur himself in terms of industry choice and individual and resource-task fit and there are strategies open to the regulators and support agencies in term of use of industrial policy tools and incentives and explicit stimulation of industrial sectors or branches. A conceptual frame that contains both dimensions could provide a convenient base for analysis and possible policy action.

Encouraging entrepreneurial initiative is an issue common to both developed and developing countries and the search for effective means is proceeding in earnest. The analysis had dealt with a way of viewing the constraints embodied in the process of creating a new business or manufacturing operation.

The slow pace of the propensity to enterprise is mainly due to the existence of a tangible set of barriers prohibiting the process of entry into, continuity in, and eventual exit from a business venture of a would-be entrepreneur is a function of forces that one may view as barriers limiting fully-fledged business performance. There may be entry barriers, survival barriers and exit barriers.

4.7.3 Importance of an Entrepreneur

Entrepreneur is one of the most important inputs in the economic development of a country or of regions within the country. Entrepreneurial competence makes all the difference in the rate of economic growth. In India, state and private entrepreneurship co-exist. The small-scale industrial sector and business are left completely to private entrepreneurs. It is, therefore, in this context that an increasingly important role has been assigned to the identification and promotion of entrepreneurs for this sector.

The need for a broad-based entrepreneurial class in Indian arises from the need to speed up the process of activating the factors of production, leading to a higher rate of economic growth, dispersal of economic activities, development of backward tribal areas, creation of employment opportunities, improvement in the standard of living of the weaker sections of the society and involvement of all sections of the society in the process of growth.

Several factors go into the making of an entrepreneur. Individuals who initiate, establish, maintain and expand new enterprises constitute the entrepreneurial class. The socio-political and economic conditions, the availability of industrial technology and know-how, state of art and culture of business and trading, existence of markets for products and services and the incentives and facilities available for starting an industry or business, all have a bearing on the growth of entrepreneurship. A conducive environment is created through the policies and interest of the government in economic and industrial development.

It is now well recognised that entrepreneurs can be developed out through appropriately designed entrepreneurship development programmes. These programmes broadly envisage a threetiered approach: developing achievement motivation and sharpening of entrepreneurial traits, and behaviour project planning and development and guidance on industrial opportunities, incentives and facilities and rules and regulations, developing managerial and

operating capabilities. Various techniques and approaches have been developed and adopted to achieve these objectives, keeping in view the target-groups and/or target area. The structuring of the programmes and training methodology also necessitate consideration of the specific target-groups and target area. Methodology for selection of the prospective entrepreneurs as well as support services after training have a significant impact on the success of the entrepreneurs development programmes.

4.7.4 Creation of a Dream

Creating a dream gives entrepreneurs the energy and desire to become involved in its implementation and to be willing to change. During the formulation of the dream, everyone participates (including the leaders), and this allows people to start seeing each other in a different light. How long they will maintain their commitment depends upon - (a) how well the organisation's leaders function in their new role of facilitating resolution of the needs or issues that are at variance with the dream (b) how clearly the leaders articulate and share information about the business needs and C how well the leaders openly acknowledge their Willingness to change in whatever fashion to attain the dreams.

The process of creating the dreams should be tailored to the situation with the objective of having the entire organisation ultimately own the dream. In a large organisation, there will be many dreams formulated by interdependent parts of the organisation. At some point, these should be integrated into a total organisational dream. We have found that creating a dream in a bottoms-up manner where all organisational levels participate in some fashion is better than a tiered, top-down approach.

To illustrate the content of a typical dream, let us look at the leadership portion of one from a Honeywell factory, which evolved as follows :

Leadership Should be the ability of those leading work units (Managers, supervisors, engineers, technical support, and group leaders) to create an atmosphere of acceptance, openness, and trust that will properly motivate members of the work units.

Interpersonal competence should be the ability to relate to people in a considerate and effective way.

This means that the leader :

1. Cares-
 - a. Gives positive feedback for a good job.
 - b. Shows confidence in employees.
 - c. Is fair and objective, not vindictive.
 - d. Practices what is preached; does not ask for something that he or she would not be willing to do.

- e. Has a down-to-earth, person-to-person approach; acts as part of a team.

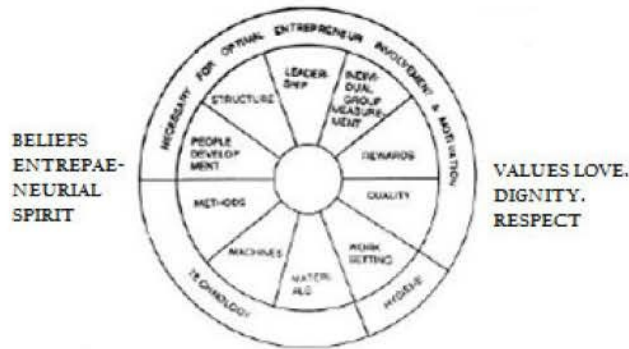

Fig. 4.4

Fig. 4.4 Basic Elements - Entrepreneurial Involvement.

- (f) Is compassionate and understanding; creates an atmosphere of acceptance and trust.
2. Skillfully communicates-
- (a) Listen actively.
 - (b) Clarifies priorities.
 - (c) Is available.
 - (d) Links management with employees, employees with management, and employees with each other. Communicates effectively to all people on all shifts through all levels of the organisation.
 - (e) Provides feedback for both goods and bad work.
 - (f) Talks openly and given straight answers about what is happening.
3. Guides, inspires-
- (a) Encourages advancement.
 - (b) Gives direction to the work unit.
 - (c) Is proud, loyal to, and supportive of employees.
 - (d) Has a sense of vision - a dream that is blended with employees dream.
 - (e) Projects a positive attitude.
 - (f) Is courageous.
 - (g) Sets a good example; is friendly, not moody.
 - (h) Enjoys his or her work.
 - (i) Keeps promises; plows through red tape.

4.7.5 Administrative competence

Should be the ability to achieve organisational goals within the bounds of the business constraints and policies and procedures. This means that the leader.

1. Understand his or her job.
2. Understand employees jobs.
 - a. Utilises people's skills effectively.

- b. Is concerned with employees work and the workflow.
- c. Stands up for and shows confidence in employees.
- 3. Takes immediate action :
 - a. Does not ignore problems.
 - b. Follows up on promises.
 - c. Gets tough when necessary.
 - d. Takes action to remove poor performers.
 - e. Assures that the next in command knows his role and has authority to act.
 - f. Provides proper human resources for all shifts and all level of organisation.

4.7.6 Entrepreneurial Decision

Entrepreneurial decision occur despite recession, inflation, high interest rates, lack of infrastructure, economic uncertainty etc. Each of these decisions is a personal human process that, although unique, has some common characteristics. The impulsive motive to change his/her life style and create something new and an inner urge to do something worthy, are the forces behind these decisions. At times, perhaps even more stimulation for change comes from a negative force-disruption. At times, the available opportunities force a decision on individuals to take up entrepreneurial work. Like all processes, it entails movement from something to something new as indicated in fig.

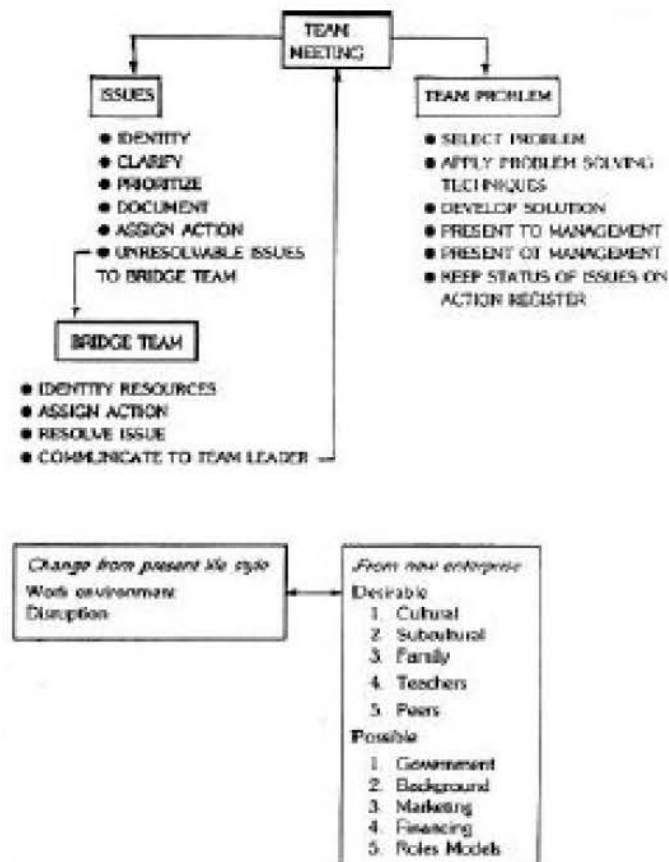

Fig. 4.5

What causes this change due to the work environment or disruption to result in a new company being formed instead of something else? the decision to start a new company occurs when an individual perceives that it is both desirable and possible.

The perception that starting a new company is desirable result from an individual's culture, sub-culture teachers, family, and peers. A culture that values an individual who successfully creates a new business will spawn more company formations than one that does not. For example, India places a high value on being yours own boss, individual opportunity, being a success and making money - all aspects of entrepreneurship. What is more, many different sub-cultures that shape value, systems are operating within a cultural framework, More importantly, these sub-cultures support and even promote entrepreneurship. Thus entrepreneurial decision has more bearing on sociological, cultural sub-cultural, psychological and political environment, while satisfaction and adequate reward are the optimistic goals.

4.7.7 Entrepreneurial Skills

To deals with entrepreneurial skills is to concern oneself with a wide coverage of aspects of setting up an enterprise and its management. It is not confined to vidulations, planning, setting-up and risk-taking.

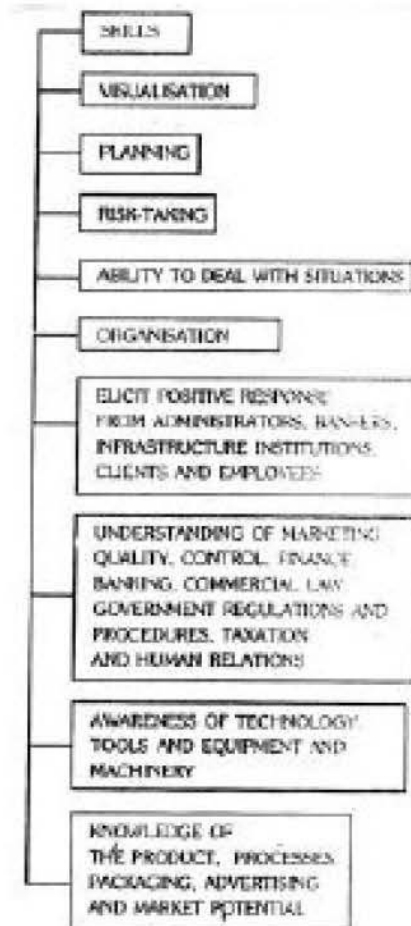

Fig. 4.6

The skill which an entrepreneur possesses include his ability to deal with new situations, organisations and social and economic forces

as they emerge from time to time. The skills to deal with a situation, fore visualised or suddenly emerging, must be an essential characteristic of an entrepreneur.

The small entrepreneur must have the skill to elicit positive response from administrators, bankers, infrastructure institutions, clients and employees.

The entrepreneur is rarely a master of all management skills, and yet is usually directly responsible for all aspects of business. Often he or she has to be the general manager, production manager, purchasing manager, personnel manager, controller and research organiser for the business, all rolled into one, at least during its early years. The entrepreneur has, therefore, to have an understanding of marketing, quality control, finance, banking, commercial law, government regulations and procedures, and human relations as each of them has a vital bearing on the health of the enterprise.

4.7.8 Need for Skills

We often talk of transfer of technology. As a matter of fact, the whole world is talking about it. There is hardly any international event at global and regional level where this subject does not come up for discussion. The poor nations demand technology and resources from industrialised and rich countries and rightly so. The developing countries would rather export semi-finished and finished products which are value added than export raw materials. The development of entrepreneurial skill must precede transfer of technology if we do not desire to keep such technologies and equipment serving such technologies idle. One has also to realise that technologies are developing very fast and skills also to match with this dynamic growth. The entrepreneur has to be made aware of the imperative needs of updated technologies, modern tools and equipment's, processes and systems and skills. In this task, his whole organisation, however small it may be, has to join the exercise.

It is observed that in many least developed countries, sophisticated equipment and machinery imported at heavy cost, often under pressure of international financial institutions or aid agreements, are lying unutilised for want of trained hands. It is obvious that the accelerated development of human resources and appropriate training of manpower must be concurrent with the transfer of technologies which are relevant to the needs of each developing country. This will call for an inventory of existing manpower, degree of their present skills, arrangements for proper imparting and skills needed. This should have a relation to natural endowment and resources and their optimum utilisation.

SUMMARY

Entrepreneurs play an important role in the development of society. For example, the use of Jeans in America has created the demand for it throughout the world. Similarly, Coca Cola has been accepted as a social drink. The introduction of colour T.V. has provided the society a means of information and entertainment. The society has accepted the innovations of such entrepreneurs as Gillet, Wright Brothers, and Henry Ford. The invention of these great entrepreneurs of the history has revolutionised the life style of men in the society.

The role entrepreneurs in economic development varies from economy to economy, country to country, depending upon its material resources, industrial climate and more importantly, the responsiveness of the political system to the growth of entrepreneurs. By and large, the entrepreneur's contribution to development and growth is relatively higher in favourable opportunity conditions than in less favourable situation. The growth of an entrepreneurial society will bear fruitful results in a shortspan.

Entrepreneurship, the de facto barometer of overall economic, social and industrial growth has brought revolutionary changes in the society. It is the sine quonon of an nation's progress. It has facilitated large-scale production and distribution. It has widened the area and scope of the marketing of goods and services. Perhaps it is for these reasons that the small business sector has been given priority in our national development programmes for entrepreneurship flourishes when the size of business remains relatively small and viable.

Modern business studies have a distinct entrepreneurial discipline. The approach to the study of entrepreneurship is multi-disciplinary. It images on such area as demography, economic anthropology, business history, politics sociology, psychology, marketing and finance. That is why entrepreneurship development becomes an integral part of the overall economic, social and industrial development of a country. This is what makes the identification and management of entrepreneurial functions a highly complex exercise.

QUESTIONS

1. What are the qualities an entrepreneur should have? Explain with justification.
2. What are the functions of the entrepreneurs?
3. Why an entrepreneur should be a decision maker?
4. What is the difference between entrepreneur and entrepreneurship?
5. What do you understand by the term opportunity matrix?
6. What is a role of an entrepreneurs?
7. What is the importance of an entrepreneurs?
8. What skills are required for entrepreneurs?

5. THE CLASSIFICATION AND TYPES OF ENTREPRENEURS

5.1 BUSINESS ENTREPRENEURS

5.2 TYPE OF ENTREPRENEURS

5.3 ENTREPRENEURS AND MOTIVATION

5.4 GROWTH AND ENTREPRENEURS

OBJECTIVE

After this unit you will be able to explain

- Classify the various Entrepreneurship.
- Understand motivation it's Entrepreneurship

THE CLASSIFICATION AND TYPES OF ENTREPRENEURS**5.1 BUSINESS ENTREPRENEURS**

In the previous chapter, we have analysed the concept of entrepreneurship and its understanding over the centuries, particularly in the post industrial revolution. In modern times entrepreneurial development has the thrust area of development planners, economic thinkers and policy makers. What is more, the entrepreneur has emerged as a kingpin of development.

By and large, entrepreneurs are found in every economic system and in every form of economic activity as well as in other social and cultural activities. They are found amongst artisans labourers, artists, importers, exporters, engineers, supervisors, bankers, industry, professionals etc. They are also found among farmers, fishermen, forest workers, tribals and so on. Some writers have also identified entrepreneurs among politicians, theologians, philosophers, bureaucrats.

This Chapter attempts to analyse different types of entrepreneurs in business as well as in different faculties of understanding. On the basis of his study of American agriculture, Clarence Danhof classified entrepreneurs into four categories, namely, innovative Entrepreneur, initiative Entrepreneur, fabian Entrepreneur and drone Entrepreneur. The other classification is based on technology, economic activity and market economy.

5.1.1 Economists' View

In economic analysis, entrepreneurial functions are supposed to be directed towards the materialistic objective of maximisation though its foundations may be of a high order such as spiritual, patriotic, social, psychological or ethnic. Entrepreneurial activity is a form-giving activity-giving form to the wishes of the society, to ideas, to the efforts of factors and to the raw material to be processed through.

J.S. Mill has listed three entrepreneurial functions :

1. Superintendence
2. Control, and
3. Direction

J.B. Say has stated that it is function of the entrepreneur to rationally combined the forces of production into a new producing organisation. J.S. Mill lists superintendence, control and direction as entrepreneurial functions.

Superintendence: to assemble the means, turn out maximum at minimum cost and to supervise the work.

Control : The flow of goods, use of finance, utilisation of machinery and the activities of the subordinates.

Direction: he is a goal-oriented person; he has to keep the organisation constantly on the path of his objective. His is an activity of producing in present what the future will demand. Mill emphasises managerial and administrative functions. Organisation and superintendence are major functions of an entrepreneur. Organisation building capacity is the most critical skill expected of an entrepreneur.

Kirzener viewed the entrepreneur as a disequilibrating force. It is the alertness to unnoticed opportunities which creates a tendency of the ever-circular flow of equilibrium. Harvey Leibenstein states, "Entrepreneur is an individual or group of individuals with four major characteristics. He connects different markets; he is capable of making market deficiencies (gap-filling); he is input completer and he creates or expands time-binding, input-transforming entities (firms).

Much has been said by this economist on Entrepreneurship. So it can be deleted. According to B.F. Hoselitz, "The primary function of entrepreneurship is the investment of time, capital and energy in economically significant pursuits; the emphasis is on decision-making on its various aspects." Another economist Harbinson enumerates four functions: in entrepreneurship the undertaking or managing of risk and handling of economic uncertainty; planning and innovation; coordination, administration and control, routine supervision. Ability to build organisation is, perhaps, Harbinson adds, the most precious of all entrepreneurial skills. Redlich's threefold division of functions ND/are :

(1) **capitalist** - employing the factors and buying raw material, setting up the organisation; (2) **managerial** - Innovation, supervision and coordination of productive activities; and (3) **entrepreneurial** - decision-making. Benjamin Higgins lists seeing opportunities for introduction of new techniques, new products and exploitation of new resource and organising factors of production into an enterprise to avail of these opportunities as they are essential for economic development.

B.C. Tandon discusses the functions of an entrepreneur in a developing economy in the context of economic, legal, political and cultural environment. Accordingly, the entrepreneur must possess (a) capacity to risk and have self-confidence; (b) technological knowledge, alertness to take existing opportunities, willingness to accept change and ability to initiate; (c) ability to marshal resources; and (d) ability of organisation and administration. He has to have tact, patience, sagacity, power of observation and ability of discriminating. He should have perseverance to overcome obstruction and fear, have the capacity to pick and choose associates and subordinates and wisely delegate authority to inspire loyalty. He must be able to develop "himself" effectively. Tandon describes entrepreneur as an "ideal-type" rather than as "social-type." Knight is said to have identified entrepreneurship with control and responsibility.

Economic functions describes above isolate the entrepreneur from the economic environ, social milieu and political ethos in which he functions. Maximisation is taken as the pole star in his voyage. It seems to be conveniently assumed that he is abundantly provided with all the resources and the market readily absorbs what he puts into it Reality is, however, full of bottlenecks and hurdles which are ignored in the above mentioned works. Small industry is a natural habitat of the entrepreneur where his role is like that of a stoker who keeps the fire burning.

5.1.2 Sociologist's View

Sociologists consider the entrepreneur as a role performer corresponding to the role expected by the society. Wishes of the society are exhibited through customs and taboos, rewards and restraints, ethnic values and child-rearing practices, nationalistic attitude and patriotic inculcations and protestant ethics. He is conditioned by the social milieu to which he belongs. According to Peter Marris, to assemble or reassemble from what is available, very concrete kind of imagination, to see what others have missed, sensitivity to business and social environment, zest in industrial development and entrepreneurial courage are the factors that make an entrepreneur. According to Flavia Derossi, coordination at every stage - inception, maintenance and expansion - is the function of an entrepreneur. She feels an entrepreneur needs two qualities : (1) An optimistic outlook that there is a possibility of change, the environment can be mastered and he himself can introduce the required change. He finds difficulties challenging and stimulating; he thrives on them. (2) In a sphere as dynamic as industry, new problems are seized upon as opportunities for testing one's own capabilities.

5.1.3 Psychologists' View

Among psychologists, Frank Young describes an entrepreneur as a change-agent. K.L. Sharma maintains that entrepreneurs are men with qualities of leadership in solving persistent professional problems; but those persons likewise demonstrate eagerness to seize unusual opportunities. T.V. Rao and Udai Pareek describe entrepreneurship as a creative and innovative response to environment. The entrepreneur is goal-oriented rather than means-oriented. He must not only have a high capacity of risk-taking but must also have a high capacity of risk-sustaining which call for high degree of self-confidence.

Economists present him as a perceiver of otherwise unnoticed opportunity, organisation builder, adapter of new profitable activity and beneficiary thereof. Sociologists present him as a personality moulded by various practices of social enforcement and values imbibed in him. Psychologically, entrepreneurship is a vigorous application of the person's energies towards the long-cherished goals.

CHECK YOUR PROGRESS

1 What is economists view

.....
.....
.....
.....
.....

5.2 TYPE OF ENTREPRENEURS

Entrepreneurs are found in various types of business occupations of varying size. We may broadly classify them as follows :

5.2.1 Business Entrepreneur

Business entrepreneurs are individuals who conceive an idea for a new product or service and then create a business to materialise their idea into reality. They tap both production and marketing resources in their search to develop a new business opportunity. They may set up a big establishment or a small business unit. They are called small business entrepreneurs when found in small business units such as printing press, textile processing house, advertising agency, readymade garments, or confectionery. In a majority of cases, entrepreneurs are found in small trading and manufacturing business and entrepreneurship flourishes when the size of the business is small.

5.2.2 Trading Entrepreneur

Trading entrepreneur is one who undertakes trading activities and is not concerned with the manufacturing work. He identifies potential markets, stimulates demand for his product line and creates a desire and interest among buyers to go in for his product. He is engaged in both domestic and overseas trade. Britain, due to geographical limitations, has developed trade through trading entrepreneurs. These entrepreneurs demonstrate their ability in pushing many ideas ahead to promote their business.

5.2.3 Industrial Entrepreneur

Industrial entrepreneur is essentially a manufacturer who identifies the potential needs of customers and tailors a product or service to meet the marketing needs. He is a product-oriented man who starts in an industrial unit because of the possibility of making some new product. The entrepreneur has the ability to convert economic resources and technology into a considerably profitable venture. He is found in industrial units as the electronic industry, textile units, machine tools or video cassette tape factory and the like.

5.2.4 Corporate Entrepreneur

Corporate entrepreneur is a person who demonstrates his innovative skill in organising and managing corporate undertaking. A corporate undertaking is a form of business organisation which is

registered under some statute or act which gives it a separate legal entity. A trust registered under the Trust Act, or a company registered under the Companies Act are example of corporate undertakings. A corporate entrepreneur is thus an individual who plans, develops and manages a corporate body.

5.2.5 Agricultural Entrepreneur

Agricultural entrepreneurs are those entrepreneurs who undertake agricultural activities as raising and marketing of crops, fertilisers and other inputs of agriculture. They are motivated to riase agricultural through mechanisation, irrigation and application of technologies for dry land agriculture products. They cover a broad spectrum of the agricultural sector and includes its allied occupations.

5.3 ENTREPRENEURS IN TECHNOLOGY

The application of new technology in various sectors of the national economy is essential for the future growth of business. We may broadly classify these entrepreneurs on the basis of the use of technology as follows :

5.3.1 Technical Entrepreneur

A technical entrepreneur is essentially compared to a "craftsman." He develops improved quality of goods because of his craftsmanship. He concentrates more on production than marketing. On not much sales generation by and does not do various sales promotional techniques. He demonstrates his innovative capabilities in matter of production of goods and rendering of services. The greatest strength which the technical entrepreneur has is his skill in production techniques.

5.3.2 Non-technical Entrepreneur

Non-technical entrepreneurs are those who are not concerned with the technical aspects of the product in which they deal. They are concerned only with developing alternative marketing and distribution strategies to promote their business.

5.3.3 Professional Entrepreneur

Professional entrepreneur is a person who is interested in establishing a business but does not have interest in managing or operating it once it is established. A professional entrepreneur sells out the running business and starts another venture with the sales proceeds. Such an entrepreneur is dynamic and he conceives new ideas to develop alternative projects.

5.4 ENTREPRENEURS AND MOTIVATION

Motivation is the force that influences the efforts of the entrepreneur to achieve his objectives. An entrepreneur is motivated

to achieve or prove his excellence in job performance. He is also motivated to influence others by demonstrating his business acumen.

5.4.1 Pure Entrepreneur

A pure entrepreneur is an individual who is motivated by psychological and economic rewards. He undertakes an entrepreneurial activity for his personal satisfaction in work, ego or status.

5.4.2 Induced Entrepreneur

Induced entrepreneur is one who is induced to take up an entrepreneurial task due to the policy measures of the government that provides assistance, incentives, concessions and necessary overhead facilities to start a venture. Most of the induced entrepreneurs enter business due to financial, technical and several other facilities provided to them by the state agencies to promote entrepreneurship. A person with a sound project is provided package assistance to his project. Today, import restriction and allocation of production quotas to small units have induced many people to start a small-scale industry.

5.4.3 Motivated Entrepreneur

New entrepreneurs are motivated by the desire for self fulfilment. They come into being because of the possibility of making and marketing some new product for the use of consumers. If the product is developed to a saleable stage, the entrepreneur is further motivated by reward in terms of profit.

5.4.4 Spontaneous Entrepreneur

These entrepreneurs start their business their by natural talents. They are persons with initiative, boldness and confidence in their ability which motivate them to undertake entrepreneurial activity. Such entrepreneurs have a strong conviction and confidence in their inborn ability.

5.5 GROWTH AND ENTREPRENEURS

The development of a new venture has a greater chance of success. The entrepreneurs a new and open field of business. The customer's approval to the new product gives them psychological satisfaction and enormous profit. The industrial units are identified as units of high growth, medium growth and low growth industries and as such we have "Growth Entrepreneur" and "Super-Growth Entrepreneur."

5.5.1 Growth Entrepreneur

Growth entrepreneurs are those who necessarily take up a high growth industry which has substantial growth prospects.

5.5.2 Super-Growth Entrepreneur

Super-growth entrepreneurs are those who have shown enormous growth of performance in their venture. The growth performance is identified by the liquidity of funds, profitability and gearing.

5.5.3 Entrepreneur and Stages of Development

Entrepreneurs may also be classified as the first generation entrepreneur, Modern entrepreneur and classical entrepreneur depending upon the stage of development. They are explained below :

First-Generation Entrepreneur :

A first-generation entrepreneur is one who starts an industrial unit by innovative skill. He is essentially an innovator, combining different technologies to produce a marketable product or service.

5.5.4 Modern Entrepreneur

A modern entrepreneur is one who undertakes those ventures which go well along with the changing demand in the market. They undertake those ventures which suit the current marketing needs.

5.5.5 Classical Entrepreneur

A classical entrepreneur is one who is concerned with the customers and marketing needs through the development of a self-supporting venture. He is a stereotype entrepreneur whose aim is to maximise his economic returns at a level consistent with the survival of the firm with or without an element of growth.

5.5.6 Innovating Entrepreneurs

Innovating entrepreneurship is characterised by aggressive assemblage in information and analysis of results, deriving from a novel combination of factors. Men/women in this group are generally aggressive in experimentation who exhibit cleverness in putting attractive possibilities into practice. One need not invent but convert even old established products or services by changing their utility, their value, their economic characteristics into something new, attractive and utilitarian. Therein lies the key to their phenomenal success. Such an entrepreneur is one who see the opportunity for introducing a new technique of production process or a new commodity or a new market or a new service or even the reorganisation of an existing enterprise.

Innovating entrepreneurs are very commonly found in developed countries. There is dearth of such entrepreneurs in underdeveloped countries. A country with little or no industrial tradition can hardly produce innovating entrepreneurs. Such entrepreneurs can emerge and work only when a certain level of development is already achieved and people look forward to change and progress.

Innovating entrepreneurs played the key role in the rise of modern capitalism through their enterprising spirit, hope of money making, ability to recognise and exploit opportunities, etc. Innovative entrepreneurs are creative and always bring in innovation in their work.

5.5.7 Imitative Entrepreneurs

Imitative entrepreneurship is characterised by readiness to adopt successful innovations by entrepreneurs. They imitate techniques and technology innovated by others. They are adoptive and more flexible.

Imitative entrepreneurs are also revolutionary and important. The importance of these humbler entrepreneurs who exploit possibilities as they present themselves and mostly on a small scale must not be underestimated. In the first place, such adaptation requires no mean ability. It often involves what has aptly been called 'subjective innovation, that is the ability to do things which have not been done before by the particular industrialist, even though, unknown to him, the problem may have been solved in the same way by others. By western standards, an imitative entrepreneurs may be a pedestrian figure, an adopter and imitator rather than a true innovator. He is more an organiser of factors of production than a creator. But in a poor country attempting to industrialise, he is nevertheless a potent change producing figure. He can set in motion the chain reaction which leads to cumulative progress. This humbler type of entrepreneur is important in undeveloped countries.

CHECK YOUR PROGRESS

2 write a note on corporate Entrepreneurship

.....

.....

.....

.....

.....

SUMMARY

It should be noted that private entrepreneurship has to harmonise economic opportunities with social and moral responsibility. As our wise people have said, unless the pursuit of wealth is integrated with the pursuit of Dharma, there could be no lasting prosperity and peace, whether within a country or among nations. The highly developed countries have realised that aggressive entrepreneurship without an ethical base can produce more harm than good, more misery than happiness and more destruction than creation. Harmonised planning of economic and moral values is a long-drawn-out process. But the goal has to be kept in mind constantly. One should remain optimistic that entrepreneurship in India will develop on these lines - to promote India's economic development on a sound basis, as an integral part of the development of the economy. The burst of creativity and innovation in emerging teleological industries holds promise for economic development and growth of technology and business. When talent is linked with technology, people recognise and then push viable ideas and the entrepreneurial process is under way.

In this time of rapid socio-economic development and technological change, the entrepreneurial spirit can be of advantage but only if we learn to use it. The entrepreneurs are the agents of change and our hope for the future.

QUESTIONS

1. What is the economist view regarding the entrepreneurs functions?
2. What are the entrepreneurs function according to ecomomists view?
3. What does the sociologist consider an entrepreneur is?
4. Describe the entrepreneur in as per the psychologists view.
5. Explain the types of entrepreneurs.
6. Differentiate between technical and non-technical entrepreneurs.
7. How motivation is related to entrepreneurs?
8. Explain growth and super growth entrepreneurs.

6. NATURE AND SCOPE OF MANAGEMENT

6.1 SCOPE OF MANAGEMENT

6.2 MEANING OF MANAGEMENT

6.3 CHARACTERISTICS OF MANAGEMENT

6.4 OBJECTIVES OF MANAGEMENT

6.5 MANAGEMENT AS A PROFESSION

6.6 ORGANISATION AND MANAGEMENT

6.7 BRANCHES OF MANAGEMENT

6.8 IMPORTANCE OF MANAGEMENT

6.9 MANAGERIAL SKILLS

OBJECTIVE

After this unit you will be able to explain

- Understand meaning & characteristic of management.
- Draw the objectives of management.
- Define management as profession.
- Role of management in organization.
- Know about various branches of management & importance.
- Basic managerial skills.
- Understand concepts, processes, types, characteristic & importance of planning.
- Design or good plan.

NATURE AND SCOPE OF MANAGEMENT

6.1 SCOPE OF MANAGEMENT

The basic unit of a society is the individual. But no individual can satisfy all his desires himself. Therefore, he unites with his fellow-beings and works in an organised group to achieve what he cannot achieve individually. Human beings are surrounded by organised groups of many kinds, viz., a family, a play group, a work group, a school, a business firm, a government etc. Management is an essential part of any group activity. It is a primary force within the group or organisation which tends to lead it towards the group goal. Management is required to plan, organise, co-ordinate and control the affairs of the organisation. It brings the human and material resources together and motivates people for the achievement of the objectives of the organisation. Without management, resources of production remain resources merely and never become production.

Management is a universal process in all organised social and economic activities. Wherever there is human activity, there is management. In our real life, we see that every activity we undertake involves an element that ensures co-ordination and cohesiveness to the activity, without which our acts would be unproductive and ineffective. Like the domain of ancient philosophers all mankind is the management's province.

In business field management is not restricted to factory, shop or office but is also useful in government enterprises, educational institutions, health services, military organisations and so on. A manager applies his knowledge and skill in a wide variety of enterprises. In any collective human effort management is a distinct activity. In the words of Peter Drucker, Management is a

multipurpose organ that manages a business, manages manager and manages workers and work."

6.2 MEANING OF MANAGEMENT

The term 'management' has been used in different senses. Sometimes it is used in the sense of managing the 'group of managerial personnel' in an organisation. At other times, management refers to the process of planning, organising staffing, directing, co-ordinating and controlling. It is also referred to as a body of knowledge, a practice and discipline. They are some who describe it as a technique of leadership and decision-making or a means of co-ordinating, while some others have analysed management as an economic resource, a factor of production or a system of authority.

Different authors on this subject have defined the term management in different ways. Some important definitions on management are discussed here :

Mary Parker Follett, "Management is the art of getting things done through people". As per this definition management is getting things done through people who may be managers or non-managers. At the level of chief executive officer, the work is got done through functional managers, at middle level the things are implemented through supervisors and at lower level of management through workers. Getting things done through others is considered to be an art. Human and technical skills play an important part in getting work from others. It requires proper planning and organisation and creation of proper work environment. The duties are assigned, powers are delegated and accountabilities are created. Proper monitoring of work of subordinates by the manager helps him in assessing their performance and correcting deviations.

Harold Koontz has given a little modified definition of management. In his words, "Management is the art of getting things done through and with people in formally organised groups."

Another aspect which has been highlighted by some authors is the process of management. They are of the view that management is related to the functions performed by managers. Some definitions in this connection can be cited as follows :

Louis Allen, "Management is what a manager does."

James Lundy, "Management is principally the task of planning, coordinating, Motivating and controlling the efforts of others towards a specific objective."

George Terry, "Management is a distant process consisting of planning, organising, activating and controlling performance to

determine and accomplish the objectives by the use of human beings and other resources." These definitions take managerial activities as basis for defining management. Management is the performing of managerial activities for the attainment of enterprise goals. The question here is who should perform the activities and also specify the nature of such activities.

Managerial activities are performed by managers. There is a problem in identify poeple in the organisation who can be called managers because there is no uniformity in giving titles to the people. So persons whose activities are to be called managerial have to be identified irrespective of their titles. The second aspect here is of the taskford be undertaken by the management. Every manager is required to direct the activities of subordinates. For this purpose he will have to plan, organise, control and co-ordinate the activities with the motive of attaining organisational goals. A manager has to use human and other sources of the organisation in such a way that business objectives are achieved.

6.3 CHARACTERISTICS OF MANAGEMENT

Management means different aspects to different aspects to different authors. Each definition lays emphasis on a particular aspect of management thereby presenting only a partial view of the total concept of management. Over a period of time managerial techniques to manage a business have undergone a change thus the nature of management can be studied as such :

6.3.1 MULTIDISCIPLINARY

Though management has developed as a separate discipline but it draws knowledge and concepts from disciplines such as sociology, psychology, economics, statistics, operations research etc. Management integrates ideas and concepts from these disciplines and uses them for improving the efficiency of the organisation. The integration of knowledge of various fields is the major contribution of management. So the disciplines concerned with human beings contribute immensely to the management.



Fig.6.1

6.3.2 Management is a Group Activity

Management is an essential part of a group activity. As no individual can satisfy all his desires himself, he unites with his

fellow-beings and works in an organised group of people working towards a common goal, some type of management becomes essential. Management makes the people realise the objective of the group and directs their efforts towards the achievement of these objectives. Massie has rightly called management as 'co-operative group'.

6.3.3 Management is Goal-oriented

Management aims to achieve economic and social objectives. It exists to achieve some definite goals or objectives. Group efforts in management are always directed towards the achievement of some pre-determined goals. It is concerned with the establishment and accomplishment of these objectives. To quote Theo Haimann, "effective management is always management by objectives". Haynes and Massie are of the opinion that without objectives management would be difficult, if not impossible.

6.3.4 Management is a Factor of Production

Management is not an end in itself but a means to achieve the group objectives. Just as land, labour and capital are factors of production and are essential for the production of goods and services, management is a factor of production that is required to co-ordinate the other factors of production for the accomplishment of pre-determined goals.

6.3.5 Management is Universal in Character

Management is applicable in all types of organisations. Wherever there is human activity, there is management. The basic principles of management are of universal application and can be applied in all organisations whether they are business, social, religious, cultural, sports, educational, politics or military. As Socrates has put it, "Over whatever a man may preside, he will be a good president if he knows what he needs and is able to provide it whether he has the direction of a chorus, a family, a city or an army." In the words of Henry Fayol, "Be it a case of commerce, politics, religions, war... in every concern there is management function to be performed."

6.3.6 Management is a Social Process

Management consists of getting things done through others. This involves dealings with people. The efforts of the human beings have to be directed, co-ordinated and regulated by management in order to achieve the desired results. It is in this sense that management is regarded as social process. Moreover, management has a social obligation to make optimum use of scarce resources for the benefit of the community as a whole. In the words of Brech, "Management is a social process entailing responsibility for the effective and economical planning and the regulation of the operation of an enterprise, in fulfilment of a given purpose or task."

6.3.7 Management is a System of Authority

Since management is a process of directing men to perform a task, authority to accomplish the work from others is implied in the very

concept of management. Authority is the power to get the work done from others and to compel them to work in a certain manner. Management cannot perform in the absence of authority. In real sense, management is a rule-making and rule-enforcing body. There is a chain of authority and responsibility among people working at different levels of the organisation. There cannot be an efficient management without well defined lines of command or superior-subordinate relationships at the various levels of decision-making.

6.3.8 Management is a Dynamic Function

Management is a dynamic function and it has to be performed continuously. It is constantly engaged in the moulding of the enterprise in an ever changing business environment. It is concerned not only with moulding of the enterprise but also the alteration of environment itself so as to ensure the success of the enterprise. In real sense, it is never-ending function.

6.3.9 Management is an Art as Well as a Science

Management is a science because it has developed certain principles which are of universal application. But the results of management depend upon the personal skill of managers and in this sense management is an art. The art of the manager is essential to make the best use of management science. Thus, management is both science and art. It should, however, be noted that the science of management is not as exact as the physical science. It is still in the evolutionary stage, may be called as an inexact science or social science.

6.3.10. Management is a Profession

In the present days, management is recognised as a profession. It has a systematic and specialised body of knowledge consisting of principles, a technique and laws and can be taught as a separate discipline or subject. This has also divorced ownership from management. Now with the advent of large-scale business, the management is entrusted in the hands of professional managers.

6.4 OBJECTIVES OF MANAGEMENT

Management is supposed to run an enterprise smoothly and effectively. The purpose of earning profits is essential to keep the business going. The main objectives of every management are the same. Some of such objectives are discussed as follows :

6.4.1 Proper Utilisation of Resources

Every management aims to utilise enterprise resources properly and economically. The proper use of men, materials and machinery will ensure reasonable cost and adequate profits. It is not only the management which will look towards business profits but other interest groups such as employees, shareholders, customers, government will also be affected by its quantum. The efforts of the management should be to make optimum use of available resources in order to achieve better results.

6.4.2 Growth and Development of Business

Managerial efforts should be to expand and diversify the business. If there is a scope to expand the existing business then efforts should be made to develop it but avenues to enter new avenues should be made to develop it but avenues to enter new avenues should also be explored. It will give stability and strength to the business.

6.4.3 Minimising Risk Element

Every business at present is facing global competition. The products from developed countries are flooding markets in India. There is a need to improve overall working for staying in such a competition. The management should plan the activities in such a way that business is able to survive under uncertain conditions. There is a need to minimise risk element and also to explore newer and better avenues.

6.4.4 Promotion of Research

The greatest drawback in Indian business is its lack luster approach towards research. Managements give hardly any importance to research activities. It restrict their strength and capacity to compete in the market. There is a need to keep ourself aware of what is going on in the market and prepare to face it. The promotion of research is the only answer at present. Management should always try to get benefits of latest technological changes and ready to face the future with confidence and zeal.

6.4.5 Better Quality Goods

The consumer has become quality conscious now. He will go for only those products which are of good quality and satisfy his needs. At present, the survival of a unit is linked to the quality of products it produces. The objective of the management is to bring out quality products so that they are accepted by the market. It will require introduction of quality standards in the business. Management should make efforts to plan production process in such a way that only quality products are produced and marketed.

6.4.6 Improving Overall Performance

The performance of every factor of production should be improved in such a way that they contribute maximum to the business. There should be targets for every factor of production and efforts should be made to achieve them. In case of any variance between targets and results, corrective measures should be taken immediately. Management should create congenial atmosphere where people feel happy and satisfied by improving their performance. The coercive methods, on the other hand, create hurdles and bring down efficiency.

6.4.7 Planning for Future

Every management thinks and plans about future. The current as well as future planning go together. The activities to be undertaken in future will be planned at present. No concern can survive if it does not plan for future. The likely business trends, future global trends, likely business laws, changing consumer preferences,

impact of social changes are the factors which will be taken into account while planning for future.

6.4.8 Mobilising Best Talent

The management should try to employ proper persons in various fields so that better results are possible. The employment of specialists in various fields will be increasing the efficiency of various factors of production. There should be proper environment which should encourage good persons to join the enterprise. Better pay scales, proper amenities, future growth potentialities will attract more people in joining the concern.

6.5 MANAGEMENT-AS A PROFESSION

Another question that arises in regard to the nature of management is whether management can be regarded as a profession or not. To determine this, we must understand the meaning and special attributes of profession. The dictionary meaning of profession is a 'calling in which one professes to have acquired specialised knowledge, which is used either in instructing, guiding or advising others.' The term 'profession has been defined in a variety of meanings by different authors. In the broad sense, it refers to any occupation by which a person earns a livelihood. In the restricted sense, it includes only 'the three learned professions' of theology, law and medicine. But in real sense, the term profession falls in between the two extremes.

In the words of Hodge and Johnson, "Profession is a vocation requiring some significant body of knowledge that is applied with high degree of consistency in the service of some relevant segment of society." A. S. Hornby has defined profession as an "Occupation especially on requiring advanced education and special training." Prof. Dalton E. McFarland lays down the following criteria or special attributes in a profession:

1. The existence of a body of specialised knowledge or techniques.
2. Formalised method of acquiring training and experience.
3. The establishment of representative organisation with professionalism as its goal.
4. The formation of ethical codes for the guidance of conduct.
5. The charging of fees, based on services, but with due regard for the priority of service over the desire for monetary reward.

Let us now apply the above-mentioned attributes to ascertain the status of management as a profession.

6.5.1 Body of Specialised Knowledge and Technique

When applied to management, it has an organised body of knowledge built up by management practitioners, thinkers and philosophers over the period of years. In this sense, we can safely say that modern management is certainly a profession. A.P.M. Fleming has rightly remarked the modern management has "a technique quite apart from the technology of the particular works concerned.

6.5.2 Formalised Methods of Acquiring Training and Experience

The management science, today, is fully equipped with formalised methods of acquiring the body of knowledge in theory and practice. To impart management education and training, there are a large number of formal institutes in various countries, including India. Several tools of management such as Business, Psychology, Business Law, Statistics, Data-processing, Operations Research and Cost Accounting, etc. have been developed. The business houses today prefer to employ those managerial personnel who have obtained a professional degree in management from some recognised institutes.

6.5.3 Establishment of Professional Associations

Professional Management Associations are being established in most of the countries (i) to regulate the behaviour of members; (ii) to create a code of conduct for guiding the activities of the profession; and (iii) to promote and build up the image of management as a profession. In India, there is All India Management Association with many local associations affiliated to this. But the main function of this association is to manage and co-ordinate the research work in the various areas of management. It is, however, true that norms of managerial behaviour have not yet been established and we do not have uniform methods of entry.

6.5.4 Code of Conduct

Members of a profession have to abide by a code of conduct. A code of conduct provides rules and regulations, norms of honesty, integrity and professional morality. In the traditional professions such as law and medicine, there exists standard code of conduct. But in the sphere of management, there exists no uniform code of conduct. There are no restrictions of licensing on the entry of management profession and judge from these standpoint, management cannot be regarded as a profession.

6.5.5 Priority of Service Over Economic Considerations

Unlike an ordinary occupation or trade, a profession, though a source of livelihood, involves the application of expert knowledge for the service of the society. For example, a doctor earns his livelihood from his profession of medicine but service to the society is uppermost in his mind. When applied to management, although there exists no code of conduct, yet we find that an increasing emphasis is being put on the social responsibilities of managers. Management aims at providing maximum efficiency at the lowest cost so as to serve the interests of employers, workers, consumers, society and the nation at large.

6.6 ORGANISATION AND MANAGEMENT

The word 'organisation' has been derived from the word 'organ' which means various limbs or parts of a body and a musical instrument. The human body is a combination of various limbs and if any one of the limbs stops functioning properly, then some defect develops in the human body. If a musical instrument is not tuned

properly, it does not produce a melodious sound. Similarly, no business activity can be undertaken without the five factors of production, viz., the land, labour capital, enterprise and organisation. The four factors may prove ineffective in the absence of the fifth-the organisation.

According to C.H. Northcott, organisation can be defined as "the arrangement by which tasks are assigned to men and women so that their individual efforts contribute effectively to some more or less clearly defined purpose for which they have been brought together." In the words of Louis A. Allen, organisation is, "the process of identifying and grouping work to be performed, defining and delegating responsibility and authority and establishing relationships for the purpose of establishing people to work most effectively together in accomplishing objectives." Although organisation and management are inter-related, yet there is a difference between two. Management is a process of planning, organising, staffing, directing and controlling. Management is a very wide term and includes organisation. Organisation is a part of management an essential part. In essence, organisation is the foundation upon which the whole management structure is built. It has been rightly said, "If management is the brain, organisation is the body of an enterprise."

CHECK YOUR PROGRESS

1. Write objective of management

.....

.....

.....

.....

.....

6.7 BRANCHES OF MANAGEMENT

Management is an all pervasive function since it is required in all types of organised endeavour. Thus, its scope is very large. The following activities are covered under the scope of management :

- (i) Planning
- (ii) Organisation
- (iii) Staffing
- (iv) Directing
- (v) Co-ordinating and
- (vii) Controlling

The operational aspects of business management, called the branches of management, are as follows :

- 1. Production Management
- 2. Marketing Management
- 3. Financial Management
- 4. Personnel Management and
- 5. Office Management

6.7.1 Production Management

Production means creation of utilities. This creation of utilities takes place when raw materials are converted into finished products. Production management, then, is that branch of management 'which by scientific planning and regulation sets into motion that part of enterprise to which has been entrusted the task of actual translation of raw materials into finished product.' It is a very important field of management, 'for every production activity which has not been hammered on the anvil of effective planning and regulation will not reach the goal it will not meet the customers and ultimately will force a business enterprise to close its doors of activities which will give birth to so many social evils'. Plant location and layout, production policy, type of production, plant facilities, material handling, production planning and control, repair and maintenance, research and development, simplification and standardisation, quality control and value analysis, etc., are the main problems involved in production management.

6.7.2 Marketing Management

Marketing is a sum total of physical activities which are involved in the transfer of goods and services and which provide for their physical distribution. Marketing management refers to the planning, organising, directing and controlling the activities of the persons working in the market division of a business enterprise with the aim of achieving the organisation objectives. It can be regarded as a process of identifying and assessing the consumer needs with a view to first converting them into products or services and then involving the same to the final consumer or user so as to satisfy their wants with a stress on profitability that ensures the optimum use of the resources available to the enterprise. Market analysis, marketing policy, brand name, pricing, channels of distribution, sales promotion, sale-mix, after sales service, market research, etc. are the problems of marketing management.

6.7.3 Financial Management

Finance is viewed as one of the most important factors in every enterprise. Financial management is concerned with the managerial activities pertaining to the procurement and utilisation of funds or finance for business purposes. The main functions of financial management include :

- i. Estimation of capital requirements;
- ii. Ensuring a fair return to investors;
- iii. Determining the suitable sources of funds;
- iv. Laying down the optimum and suitable capital structure for the enterprise;
- v. Co-ordinating the operations of various of various departments;
- vi. Preparation, analysis and interpretation of financial statements :
- vii. Laying down a proper dividend policy; and
- viii. Negotiating for outside financing.

6.7.4 *Personnel Management*

Personnel Management is that phase of management which deals with the effective control and use of manpower. Effective management of human resources is one of the most crucial factors associated with the success of an enterprise. Personnel management is concerned with managerial and operative functions. Managerial functions of personnel management include :

- i. Personnel planning;
- ii. Organising by setting up the structure of relationship among jobs, personnel and physical factors to contribute towards organisation goals;
- iii. Directing the employees; and
- iv. Controlling.

The operating functions of personnel management are :

- i. Procurement of right kind and number of persons;
- ii. Training and development of employees;
- iii. Determination of adequate and equitable compensation of employees;
- iv. Integration of the interests of the personnel with that of the enterprise; and
- v. Providing good working conditions and welfare services to the employees.

6.7.5 *Office Management*

The concept of management when applied to office is called 'office management'. Office management is the technique of planning, co-ordinating and controlling office activities with a view to achieve common business objectives. One of the functions of management is to organise the office work in such a way that it helps the management in attaining its goals. It works as a service department for other departments.

The success of a business depends upon the efficiency of its administration. The efficiency of the administration depends upon the information supplied to it by the office. The volume of paper work in office has increased manifold in these days due to industrial revolution, population explosion, increased interference by government and complexities of taxation and other laws.

Harry H. Wylie defines office management as "the manipulation and control of men, methods, machines and material to achieve the best possible results—results of the highest possible quality with the expenditure of least possible effort and expense, in the shortest practicable time, and in a manner acceptable to the top management."

6.8 **IMPORTANCE OF MANAGEMENT**

Management is the art of securing maximum prosperity with a minimum of effort. Wherever there is an organised group of people working towards common goals, some type of management becomes essential. It has been rightly said that 'anything minus management amounts to nothing.' In the words of Koontz and O'

Donnel, "There is no more important area of human activity than management since its task is that of getting things done through others."

In the case of business enterprise, management is all the more important, because "no business runs on itself, even on momentum, every business needs repeated stimulus which can only be provided by management. According to Peter F. Drucker, "Management is a dynamic life giving element in an organisation. In its absence the resources of production remain resources and never become production."

The following points further highlight the importance of management :

6.8.1 Achievement of Group Objectives

It is the management which makes the people realise the objectives of the group and directs their efforts towards the achievement of these objectives. It brings the human and material resources together to mobilise the people for the achievement of the objectives of the organisation.

6.8.2 Optimum Utilisation of Resources

No business activity can be undertaken without the five factors of production viz., the land, labour, capital, enterprise and the management. The four factors may prove ineffective in the absence of the fifth-the management. It is the management which makes optimum utilisation of resources possible. In the words of urwick and Brech, "No ideology, no ism, no political theory can win greater output with less efforts, only sound management."

6.8.3 Minimisation of Cost (to combat rising competition)

In the present days of increasing competition, only those business enterprises can survive which can produce quality goods at the lowest of costs. Through better planning, sound organisation and effective control, management enables a concern to reduce costs and enables an enterprise to face cut-throat competition.

6.8.4 Increased Profits

Profits can be increased in any organisation either by increasing the sales revenue or reducing cost. To increase the sales revenue is beyond the control of an organisation. Management by reducing costs increases its profits and provides opportunities for future growth and development.

6.8.5 Smooth Running of Business

Management ensures efficient and smooth running of business through better planning, sound organisation, effective control and the various tools of management.

6.8.6 Provides Innovation

Management provides new ideas, imagination and visions to the organisation.

6.8.7 Change of Growth

An enterprise operates in an changing environment. Management moulds the enterprise in such a changing environment. It moulds not only the enterprise but also alters the environment itself to ensure the success of the business. In order to meet the challenge of automation and the complexities of advanced technology also there is a needs for the development of management.

6.8.8 SOCIAL BENEFITS

Management is beneficial not only to the business enterprises but to the society as a whole. It raises the standard of living of the people by providing good quality products and services at the lowest possible cost. It also makes the optimum use of scarce resources and promotes peace and prosperity in the society.

6.8.9 Special Importance of Management in India's Developing Economy

Management has to play a more vital role in the developing countries like India, where productivity is low and the resources limited. It has been rightly said, "There are no under-developed countries. There are only under-managed ones.

6.9 MANAGERIAL SKILLS

A skill is an acquired and learned ability to translate knowledge into performance. It is the competency of a person that allows his performance to be superior. A manager has to achieve organisational objectives through the proper use of available human and material resources. All managers need to possess various skills which are necessary to carry out their jobs successfully managerial are explained as follows :

6.9.1 Technical Skills

Technical skills basically involve the use of knowledge, methods and techniques in performing the job effectively. It is a specialised expertise which is used in dealing with day to day problems and activities. Technical skills are necessary to accomplish or understand the specific kind of working done in an organisation. Engineers, scientists, computer programmers etc. are the persons who have technical skills in their areas and these skills are acquired through education and training. Technical skills are essential for first line managers who spend their time in training their subordinates and clear their doubts regarding work. As one goes higher in managerial leader, the need of technical skill diminishes.

6.9.2 Human Skills

Human skill is the ability to work with other people in a co-operative manner. It involves patience, understanding, trust and genuine involvement in interpersonal relationships. Human relations skill is necessary at every level of management. The success of companies is linked to their success in having excellent relationship with employees. A manager with good human skills can build trust and co-operation and can motivate others. The businesses are becoming multinational and global, managers are required to learn new ways of dealing with people in different countries with different cultures and value systems.

6.9.3 Analytical Skills

Analytical skills are also called diagnostic skills. Analytical skill refers to an ability of logically and objectively investigating and analysing a problem and reaching an appropriate decision. Analytical skills are approaches which are scientific to arrive at feasible and optimal solution. In essence, it is the ability of a person to identify key factors and understand as to how they interrelate and the roles they play in a given situation. Analytical skills help a manager to establish cause and effect relationship. These skills also help a manager for problem identifying, solving and decision making.

6.9.4 Decision-making Skills

Every manager is required to make decisions every day. Decision-making is an essential element of management. Decision making is the process of reaching a point. It is choosing the best alternative of doing a thing from the various choices available. A manager may make use of various techniques available for taking decisions. Manager's decisions can make or mark the future of the company. The quality of decisions will improve if possesses decision making skills.

6.9.5 Conceptual Skills

Conceptual skill is the ability to view the organisation as a whole and as a total entity as well as a system comprised of various parts and subsystems integrated into a single unit. Managers should have the ability to understand the overall working of the organisation and harmonise the working of the sub-systems for reaching the organisational objectives.

Conceptual skills are crucial for top level managers who must keep the whole system under focus. They must understand the complexities of overall organisation, including how each unit of the

organisation contributes towards the overall success of the entire organisation. Conceptual skills will depend upon an organised thinking process which deals with understanding of various organisational functions, their interdependence and the relationship of the organisation with the outside environment in terms of threats and opportunities.

6.9.6 Communicational Skills

Communication skills are an important element of interpersonal skills. Communication is essential for proper implementation of orders. The best ideas of a manager may not be of any use if these are not properly communicated to be subordinates. Good communication is the foundation of sound management. Proper communication eliminates delays, misunderstanding, confusion, distortions and improves co-ordination and control. Communication skills are essential at every level of management. The communicational skills namely reading, writing, listening and non-verbal gestures are important ingredients of successful leadership.

6.9.7 Political Skills

Political skills can be described as the ability to get your own way without demonstrating selfish or self-oriented attitude. These are the skills to get your share of power and authority and use it without fear of losing it. It is an approach to establish right connections and impressing the right persons and then using those connections for the full advantage of the organisation. These skills are important at the middle level of management because those level managers always aspire to reach the top level of management, right type of connections help such aspirants.

CHECK YOUR PROGRESS

2. Write a note on office management

.....

.....

.....

.....

.....

SUMMARY

The above discussion shows that management in some respects qualify as a profession but it does not have certain features which generally constitute a recognised profession. The saying is that "Managers are born, and not made" is no longer valid in the present days. Although, Peter F. Drucker, the greatest exponent of management theory and practice, is of the view, "No greater damage could be done to our economy or to our society than attempt to professionalise management by licensing managers or by limiting access to management to people with a special academic degree." Management is now backed by a systematised body of knowledge and a number of principles, techniques and tools have been developed which need proper learning, education and training. To conclude, we may say that although management does not possess all the essential attributes of a profession, it is no doubt emerging as a profession.

QUESTIONS

1. Write the definition of management and explain.
2. What do you understand by management? Explain with definition and features.
3. What are the objectives of the management?
4. Can management be regarded as profession or not? Give reasons to support your answer.
5. What are the various activities that are covered under the scope of management.
6. What are the various branches of management?
7. What is the importance of management?
8. What skills are required for management?

7. PLANNING (CONCEPT, PROCESS & TYPES)

7.1 IMPORTANCE OF PLANNING

7.2 DEFINITION OF PLANNING

7.3 CHARACTERISTICS OF PLANNING

7.4 IMPORTANCE OF PLANNING

7.5 A GOOD PLAN

7.6 ADVANTAGES OF PLANNING

OBJECTIVE-

After this unit you will be able to explain

- Understand concepts, process & types, characteristic & importance of planning.
- Design a good Plan
- Understand concepts, theory, significance & types of organization.
- Analyze organization.
- Comprehend group dynamics & organization development

PLANNING (CONCEPT, PROCESS & TYPES)

7.1 IMPORTANCE OF PLANNING

Planning is 'task number one' of management. It is the determination of a course of action to achieve a desired result. Planning concentrates on setting and achieving objectives of an organisation. It is deciding in advance what to do, how to do it, when to do it and who is to do it. Planning bridges the gap from where we are to where we want to go. Planning makes it possible to occur which would not otherwise happen. It is an intellectual process; it is characterised as the process of thinking before doing. It is cent per cent mental work. It requires a mental predisposition to think before acting, to act in the light of facts rather than of guesses, and generally speaking, to do things in an orderly way. Planning function of management precedes all other managerial functions. Without setting the goals to be reached and line of actions to be followed, there is nothing to organise, to direct, or to control in the organisation. Only after having made his plans can the manager organise, staff, direct and control. Planning actually is the foundation of management.



Fig. 7.1

The vital supporting columns of 'organizing,' actuating and 'controlling' upon 'planning'; and all these combined together make up the bridge or 'Process of Management'.

Planning governs the survival, progress and prosperity of any organisation in a competitive and ever-changing environment. Further, the planning function is performed by managers at every level of management. However one should not induct from this view that planning is an isolated activity required in the beginning only. It is really a continuous and unending process to keep the organisation as a going concern and other functions are also performed simultaneously.

7.2 DEFINITION OF PLANNING

Planning is deciding in advance what is to be done. It involves the selection of objectives, policies, procedures and programmes from among alternatives. A plan is a pre-determined course of action to achieve a specified goal. It is a statement of objectives to be achieved by certain means in the future. In short, it is a blue-print for action.

The following definitions of planning are quite illuminating :

7.2.1 David Cleland and William King

"Planning is the process of thinking through and making explicit the strategy, actions and relationships necessary to accomplish an overall objective or purpose."

7.2.2 George R. Terry

"Planning is the selecting and relating of facts and the making and using of assumptions regarding the future in the visualisation and formulation of proposed activities believed necessary to achieve desired results."

7.2.3 Louis A. Allen

"Management planning involves the development of forecasts, objectives, policies, programmes, procedures, schedules and budgets."

7.2.4 Billy E. Goetz

"Planning is fundamentally choosing. A planning problem arises only when an alternative course of action is discovered."

7.2.5 Theo Haimann

"Planning is deciding in advance what is to be done. When a manager plans, he projects a course of action for the future, attempting to achieve a consistent, coordinated structure of operations aimed at the desired results."

7.2.6 Koontz O'Donnell

"Planning is an intellectual process, the conscious determination of courses of action, the basing of decisions on purpose, acts and considered estimates."

7.2.7 Alford and Beatty

"Planning is the thinking process, the organised foresight, the vision based on fact experience that is required for intelligent action.

7.3 CHARACTERISTICS OF PLANNING

On the basis of the above definitions, the following characteristics of planning can easily be identified :

1. Planning is very closely associated with the goals or objectives of the organisation. The goals may be express or implied; however, well-defined goals lead to efficiency in planning.
2. Planning is mainly concerned with looking ahead in the future. Forecasting provides the necessary raw material for correct planning.
3. Planning involves the selection of the best alternative.
4. Planning is required at all levels of management. However, its scope and importance increase at successively higher levels.
5. Planning is an inter-dependent process; it co-ordinates the activities of various departments, sections and sub-sections
6. Planning is flexible as it is based on future conditions which too are dynamic.
7. Planning is a continuous and unending process.

7.4 IMPORTANCE OF PLANNING

Planning is an orderly approach to the task of management. In the absence of planning, business decisions would become random, ad hoc choices, like a pilot who has started without knowing whether he wished to fly to Mumbai, Kolkata, Chennai or Delhi. As a managerial function planning is important due to the following reasons :

7.4.1 To manage by objectives

All the activities of an organization are designed to achieve certain specified objectives. However, planning makes these objectives more concrete and tangible by focussing attention on them.

7.4.2 To offset uncertainty and change

Future is always full of uncertainties and changes. However, some of the uncertainties and changes can be predicted on the basis of forecast. Thus, planning foresees the future and makes the necessary provision for it. Even where the future is certain for sometime, planning is necessary to evaluate the alternate courses of action and determine the ones leading to the continuous growth and prosperity of the organisation.

7.4.3 To secure economy in operation

Planning involves the selection of most profitable course of action that would lead to the best result at the minimum costs.

7.4.4 To help in co-ordination

Co-ordination is, indeed, the essence of management, the planning is the base for it. Without planning it is not possible to co-ordinate the different activities of an organisation.

7.4.5 To make control effective

The controlling function of management relates to the comparison of the planned performance with the actual performance. In the absence of plans, a manager will have no standards for controlling other's performance. In short, planning without control would be a fruitless exercise and control without planning is an impossibility.

7.4.6 To increase organisational effectiveness

Mere efficiency in the organisation is not important; it should also lead to productivity and effectiveness. Planning enables the manager to measure the organisational effectiveness in the context of the stated objectives and take further actions in this direction.

7.5 A GOOD PLAN

According to L.F. Urwick, 'Good Plan' is that which (i) is based on a clearly defined objective, (ii) is simple, (iii) provides for a proper analysis and classification of actions, i.e., which establishes standards, (iv) is flexible, (v) is balanced, and (vi) uses available resources to the utmost before creating new authorities and new resources. The best test of effective planning is its realistic and viable nature. A good plan must be pragmatic and must lead the organisation forward on the path of progress and prosperity. A good plan opens up new avenues, new ways of doing things and reveals specific opportunities previously unknown to the planner.

7.6 ADVANTAGES OF PLANNING

The advantages of planning may be summarized below :

1. The business objectives can be easily secured through plan because planning enables a purposeful and orderly set of activities instead of random action. It provides co-ordinated efforts and reduces risks and uncertainties.
2. Planning facilitates the process of decision-making.
3. Planning helps the management to implement future programmes in a systematic manner so that the management may get the maximum benefit out of the programmes chalked out. It enables all the activities to be conducted in an orderly and coordinated manner to achieve the common goals of the organisation.
4. With the rapid growth of technological development, it is essential for a manager to keep abreast of the latest technology, otherwise the products are likely to get obsolete. Planning helps in this process.
5. Planning indirectly leads to large-scale economics by avoiding waste of men, money, materials and machinery.
6. Planning leads to budgeting and budgeting leads to budgetary control; thus the success of budgetary control depends considerably on effective planning. It is at the

planning stage that the future prospects of an undertaking are taken care of.

7. Planning encourages the sense of involvement and team spirit. Planned targets provide a basis upon which good performances can be rewarded and poor performances can be taken care of.
8. Planning is the essence of all management activities; once planning is done well, other activities automatically follow.
9. A greater utilization of the resources and available facilities can be made because of planning. This reduces costs and results in higher profitability.

The managerial process will go through many cycles before the desired objectives are realised. Hence, it is advisable to look at the planning function as a continuous function of the manager.

7.7 PLANNING LEVELS

The planning function has to be performed at all the three levels of management right from apex or top management down to the first line managers, viz., foremen or supervisors. In participative management even the operatives take keen interest in planning their work. Of course, the higher one goes in the management structure, the more time will be spent on the planning functions. The planning functions of the different managers in the hierarchy of management may be outlined as below :

7.7.1 Top Management

Apex or top management has to devote much more time to planning and policy-making. It normally undertakes strategic planning covering a time span of one to five or even ten years. Strategic planning mostly relates to resource mobilization. It is also concerned with the strategies or courses of action, programmes, policies, procedures and standards that will determine the procurement, use and disposition of these resources. In short, top management is concerned with strategic plans which are long-range plans.

7.7.2 Middle Management

Middle management has to formulate short-term and/or tactical plans and devotes relatively less time to planning and more time to coordination and communication. It is concerned with administrative or tactical planning that supports the strategic planning.

Specific plans for the different areas of management discipline, such as, personal, production and marketing are implemented by middle management. Examples of administrative or tactical planning are : Research and Development, Marketing, Manufacturing, Finance etc. Administrative plans are mostly medium-range plans.

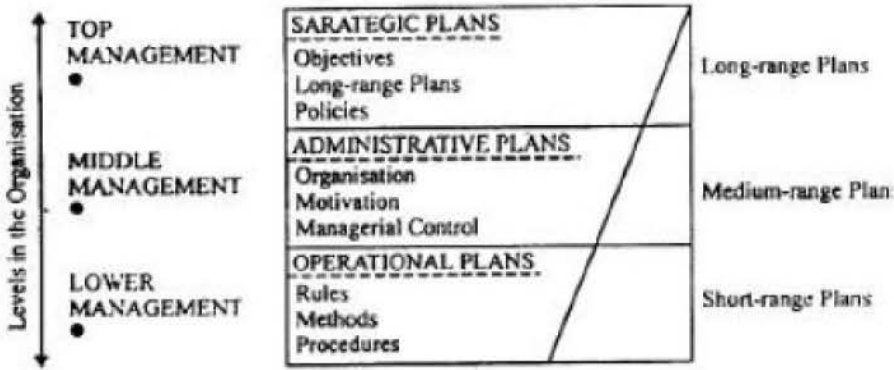

Fig. 7.2

7.7.3 Lower Management

Lower management is directly concerned with operational planning. At this level, the first-line managers such as the heads of departments and sections concentrate on planning of daily, weekly and monthly operational. In short, it relates to short-range plans. Typical examples of operational planning are : plans for finished goods inventories to meet current market demands, plans to accelerate research projects which are behind schedule, plans of routing, scheduling and dispatch in production, cash-flow budget, etc. All operational plans are concerned with the planning structures and repetitive activities in the different departments of the organisation.

CHECK YOUR PROGRESS

1. Write some advantage of planning

.....

.....

.....

.....

.....

SUMMARY

Planning is 'task number one' of management. It is the determination of a course of action to achieve a desired result. Planning concentrates on setting and achieving objectives of an organisation. It is deciding in advance what to do, how to do it, when to do it and who is to do it. Planning bridges the gap from where we are to where we want to go. Planning is deciding in advance what is to be done. It involves the selection of objectives, policies, procedures and programmes from among alternatives. A plan is a pre-determined course of action to achieve a specified goal.

It is a statement of objectives to be achieved by certain means in the future. In short, it is a blue-print for action. 'Good Plan' is that which (i) is based on a clearly defined objective, (ii) is simple, (iii) provides for a proper analysis and classification of actions, i.e., which establishes standards, (iv) is flexible, (v) is balanced, and (vi) uses available resources to the utmost before creating new authorities and new resources. The best test of effective planning is its realistic and viable nature. A good plan must be pragmatic and must lead the organisation forward on the path of progress and prosperity. A good plan opens up new avenues, new ways of doing things and reveals specific opportunities previously unknown to the planner.

The planning function has to be performed at all the three levels of management right from apex or top management down to the first line managers, viz., foremen or supervisors. In participative management even the operatives take keen interest in planning their work. Of course, the higher one goes in the management structure, the more time will be spent on the planning functions.

QUESTIONS

1. What is importance of planning?
2. Define Planning.
3. What are the characteristics of planning?
4. What do you understand by a "Good Plan"?
5. What are the advantages of planning?
6. Explain the levels of planning.

8. CONCEPT OF ORGANIZATION (SIGNIFICANCE, PROCESS AND NATURE)

8.1 ORGANISATION CONCEPT

8.2 DEFINITIONS OF ORGANISATION

8.3 ORGANISATION THEORY

8.4 FORMAL AND INFORMAL ORGANISATION

8.5 SIGNIFICANCE OF ORGANISATION

8.6 THE PROCESS OF ORGANISATION PROCESS

8.7 ANALYSIS OF ORGANISATION

8.8 NATURE OF ORGANISATION

8.9 ORGANISATION AS AN ART

8.10 GROUP DYNAMICS

8.11 ORGANISATION DEVELOPMENT

OBJECTIVE

After this unit you will be able to explain

- Understand concepts, theory, significance & types of organization.
- Analyze organization.
- Comprehend group dynamics & organization development.

CONCEPT OF ORGANIZATION (SIGNIFICANCE, PROCESS AND NATURE)

8.1 ORGANISATION CONCEPT

Organisation is the foundation upon which the whole structure of management is built. It is the backbone of management. Without organizing managers cannot function as managers. Organization is concerned with the building, developing and maintaining of a structure of working relationships in order to accomplish the objectives of the enterprise. Organisation means the determination and assignment of duties to people, and also the establishment and the maintenance of authority relationships among these grouped activities. It is the structural framework with which the various efforts are coordinated and related to each other. The success or the failure of an enterprise depends largely on the nature of organisation. The distinguished industrialist of America, Andrew Carnegie has shown his confidence in organisation by stating that : "Take away our factories, take away our trade, our avenues of transportation, our money. Leave us nothing but our organisation, and in four years we shall have re-established ourselves."

8.1.1 An Organisation

The term 'Organization' Refers to a mechanism which enables men to live together. In a static sense an organisation is a structure manned by group of individuals who are working together towards a common goals. In a dynamic sense organisation is a-process of welding together a framework of positions which can be used as a management tool for the most effective pursuit of an enterprise Organisation is coordinative and unifying, and concerns itself with a well-planned division of the numerous functions and the devolutions of duties and responsibilities to the individual executive and subordinate official supported by a rigid system of supervision and coordinated control, in order to ensure the effective execution of the plans as formulated by those in administrative authority. Some regard it as a network of relationships, a blue-print of how the management will like the various functions and activities to be assigned and connected together. Some others look upon it as a system with inputs (men, materials and machines in cases of business), and processes through which there are converted into outputs (e.g., goods and services profits, etc.).

8.2 DEFINITIONS OF ORGANISATION

8.2.1 *Chester I. Barnard*

'Organisation system of co-operative activities of two or more persons'.

8.2.2. *LOUISA A. ALLEN*

'Organisation is the process of identifying and grouping the work to be performed, defining and delegating responsibility and authority, and establishing relationships for the purpose of enabling people to work most effectively together in accomplishing objectives.'

8.2.3 *Sheldon*

'Organisation is the process of combining the work which individuals and groups have to perform with the faculties necessary for its execution that the duties so formed provide the best channels for efficient, systematic, positive and coordinated application of the available effort.'

8.2.4. *Theo Haimann*

'Organizing is the process of defining and grouping the activities of the enterprise and establishing the authority relationships among them. In performing the organizing function, the manager defines, departmentalises and assigns activities so that they can be most effectively executed.'

8.2.5 *Mooney and Railey*

'Organisation is the form of every human association for the attainment of a common purpose'. They visualise it as the process of relating specific duties or functions in a coordinated whole.

8.2.6 *John M. Pfiffner and Frank P. Sherwood*

'Organisation is the pattern of ways in which large numbers of people, too many to have intimate face-to-face contact with all others, and engaged in a complexity of tasks, relate themselves to each other in the conscious, systematic establishment and accomplishment of mutually agreed purposes.'

Like the management, the term organisation has also two meaning; as a collective noun, it refers to a particular group of individuals and as an abstract noun, it refers to the concept of the process by which a leader groups his men in order to get the work done. McFerland has defined organisation as 'an indentifiable group of people contributing their efforts towards the attainment of goals'. According to North Whitehead, 'Organization is the adjustment of diverse elements, so that their mutual relationships may exhibit more pre-determined quality'.

8.3 ORGANISATION THEORY

Organisation theory may be defined as the study of structure, functioning and performance of organisations and the behaviour of groups and individuals within them. There are following three different approaches in this connection."

8.3.1 The Classical Theory

The classical writers have viewed organisation as a machine and human beings as different components of that machine. It has its origin in the writings of Taylor. However the main ideas of this theory have been developed by Mooney, Brech, Allen and Urwick. According to classical approach, where organization is treated as machine, the efficiency of the organisation can be increased by making each individual efficient in it.

8.3.2 Neo-Classical Theory

It has introduced the human relations approach in the classical theory of organisation. The main propositions of this theory are; (1) The organisation in general is a social system composed of several interacting parts; (2) The social environments on the job affect people and are also affected by them; (3) Besides formal organisation, informal organisation also exists and it affects and is affected by formal organisation; (4) Integration between organisational and individual goals is a must; (5) Man's behaviour can be predicted in terms of social factors at work; (6) man is diversely motivated and socio-psychological factors are important; (7) Man's approach is not always rational; (8) Team-work is essential for co-operation and sound organisational functioning; and (9) Effective communication is necessary for sound organisation.

8.3.3 Modern Organisation Theory

This theory views the organisation as a system and studies it in its totality as a complex of human interrelationships. Scott observes that the distinctive qualities of modern organisation theory are its conceptual-analytical base, its reliance on empirical research data and above all, its integrating nature.

<p>CHECK YOUR PROGRESS</p> <p>1 Write the concept of organization</p> <p>.....</p> <p>.....</p> <p>.....</p>

8.4 FORMAL AND INFORMAL ORGANISATIONS

Many people distinguish between formal and informal organisation Barnard referred to an organisation as formal when the activities of two or more persons are consciously coordinated toward a given objective. He found that the essence of formal organisation is conscious common purpose and that the formal organisation comes into being when persons (i) are able to communicate with each other, (ii) are willing to act, and (iii) shares a purpose. The informal organisation refers largely to what people do because they are human personalities-to their actions in terms of Needs, emotions and attitudes, not in terms of procedures and regulations. In the

informal organisation, people work together because of their personal likes and dislikes. We may clarify this basic distinction further along the following lines :

1. Formal organisation is established with the explicit aim of achieving well-defined goals. It is meant to engage in production of goods and/or in performing of certain services required by society. The goals of formal organisation generally center around stability, survival, growth, private profit, public welfare and so on. Informal organisation is not established as such. It springs on its own as a complex of small informal groups. Its goals are ill-defined and intangible like friendship, goodwill, understanding, unity and so on.
2. Formal organisation is bound together by authority relationships among the members. A hierarchical structure is created, constituting top management, middle management and supervisory management. The structure can be represented by an organisational chart. Informal organisation is characterised by a generalised sort of power relationships. Power in informal organisation has bases other than rational-legal right. The power structure in informal organisation is very complex and is uncharitable.
3. Formal organisation recognises certain tasks and activities which are to be carried out to achieve its goals. These tasks are divided and sub-divided. Informal organisation does not have any well-defined tasks; nor are they divided and sub-divided.
4. The roles and relationships of people in formal organisation are impersonally defined. They are supposed to structure their behaviour in accordance with certain prescribed and required performance of tasks, interactions and relationships. In informal organization, the relationships among people are interpersonal and not impersonal. No specific rules and relationships are prescribed but they evolve as a matter of course. Certain collectively accepted norms of behaviour guide people in their relationship.
5. In formal organisation, much emphasis is placed on efficiency, discipline, conformity, consistency and control. All these elements tend to introduce rigidity, bureaucracy and artificiality in the process and practice of formal organisations. Informal organisation is characterised by relative freedom, spontaneity, homeliness and warmth.
6. The focus of the entire activity of the formal organisation is on effective achievement of organisational goals and promotion of organisational interests. The social and psychological needs and interests of members of the organisation get little attention. Members are supposed to partially suppress their views, feelings and needs for the sake of the formal organisation. But in informal organisation, the socio-psychological needs, interests and aspirations of members get priority. In fact, informal organisation emerges

basically to cater to the social needs and sentiments of its members. The goals of the informal organisation and those of its members are almost totally congruent.

7. The communication system in a formal organisation follows certain pre-determined patterns and paths. In informal organisation, the communication pattern is often compared to a 'grapevine' which is haphazard, intricate and natural.
8. Formal organisation exhibits certain established habit patterns and ways of doing things. It is relatively slow to respond and adapt to changing situations and realities. As against this, informal organisation is in a flux organisation develops its own culture and character, such a condition does not prevent it from being sensitive to its surroundings.

8.5 SIGNIFICANCE OF ORGANISATION

Organisation, in its simplest sense, means a form of human association for the attainment of common objectives. Since ages and in every walk of life, organisation has been playing a vital role. Organised thoughts have always been the basis of organised actions. An industrial organisation also denotes a type of association of persons in relationship to some economic activities. Obviously, the better the organisation the fuller would be the achievement of the common objectives and similarly, loose organisation of an enterprise implies an unhappy, better say, dangerous state of affairs.

Some of the principal advantages of organisation may be outlined as below :

8.5.1 Facilitates administration

A properly designed and balanced organisation facilitates both management and operation of the enterprise; inadequate organization may not discourage but actually preclude effective administration. Sound organisation facilitates delegation. This is particularly true of managers who are so busily concerned with doing work that should be handled by subordinates that they have no time to perform their management responsibilities. The planned organisation relieves this situation. By proper division of labour, consistent delegation and clear job definition, the organisation structure siphons off the routine duties and makes them the responsibility of lower rated positions.

8.5.2 Facilitates growth and diversification

The organisation structure is the framework within which the company grows. Expansion and diversification can proceed further than the organisation structure permits. Some types of organisations are ideally suited to the small company in its early stages of growth; however, these same structures may prove inadequate as growth and diversification occur. The firm primarily concerned with day-to-day operations often grows beyond the scope of its existing organisation and finds itself in a serious administrative crisis before it undertakes the necessary basic

organisation changes. On the other hand the alert, managed enterprise anticipates the need for change to facilitate group before it is hampered by the shackles of its own making.

8.5.3 Provides for optimum use of technological improvement

Now, technological developments increasingly influence the need of more adequate organisation structure and for understanding the proper forms of organisation best designed to accommodate these new factors. The high cost of installation operation and maintenance of such equipments calls for proper organisation.

8.5.4 Encourages human use of human beings

The organisation structure can profoundly affect the people of the company. Proper organisation facilitates the intensive use of the human capital.

8.5.5 Stimulates creativity

Sound organisation stimulates independent, creative thinking and initiative by providing well-defined areas of work with broad latitude of the development of new and improved ways of doing things.

In Short, properly conceived, the organisation structure will demand creative results from creative people and will drain routine and repetitive work to supporting positions. By establishing clear-cut accountability, it will provide recognition for the professional and the specialist in terms of their achievement.

8.6 ORGANISATION PROCESS

The process of organisation may be described as the managerial function of organising. It consists in making a rational division of work into groups of activities and tying together the position representing grouping of activities so as to achieve a rational, well-coordinated and orderly structure for the accomplishment of work. Important steps involved in this process are :

8.6.1 Determination of objectives

It is the first step in building up an organisation. It will consist in deciding as to why the proposed organisation is to be set up and therefore, what will be nature of the work to be accomplished through the organisation.

8.6.2 Enumeration of activities

Then the total job is sub-divided into essential activities, e.g., the work of an industrial concern may be divided into the following major functions : (i) purchasing, (ii) production, (iii) financing, (iv) personnel, (v) sales, (vi) export promotion etc.

8.6.3 Grouping activities

Then closely related and similar activities are grouped into divisions and departments and the departmental activities are further divided into sections. Different bases are adopted for the purpose of dividing and subdividing the activities into groups. Functions like sales,

production, finance, etc., are made the basis of primary grouping. Secondary grouping is made on the basis of geographical area, types of customers, equipments used, processes adopted or constituent parts of major enterprise function.

8.6.4 Allocation of fixed responsibility to definite persons

Here specific job assignments are made to different subordinates for ensuring a certainty of work performance.

8.6.5 Delegation of authority

Authority without responsibility is a dangerous thing and similarly responsibility without authority is an empty vessel. Hence, corresponding to the responsibility authority is delegated to the subordinates for enabling them to show work performance.

8.7 ANALYSIS OF ORGANISATION

Peter F. Drucker, in his distinguished book 'The practice of management' has observed that : "Organisation is not an end in itself, but a means to the end of business performance and business results. Organisation structure is an indispensable means; and the wrong structure will seriously impair business performance and may even destroy it. Organisation structure must be designed so as to make possible to attainment of the objectives of the business for five, ten, fifteen years hence." According to Drucker, there are three specific ways to find out what type of structure is required to attain the objectives of an enterprise, viz., (i) Activities Analysis, (ii) Decision Analysis, and (iii) Relations Analysis.

8.7.1 Analysis of Activities

The first stage in building an organisation is to find out what activities are needed to attain the objectives of the enterprise. Each business has a set of specific functions to perform, such as, manufacturing, marketing, engineering, purchasing, personnel, accounting etc. These functions can be applied everywhere and to everything with prior analysis. But if we carefully analyse the activities of the various businesses, we shall observe that each will have some specific functions which may be more important than the typical function mentioned above. For example, quality job printing may be an important function of a printing press; designing may be the most important activity of women's dress manufacturer. Thus, an objective and specific analysis of the activities must be attempted before designing the organisational structure of an enterprise.

Once the activities have been identified and listed in their order of importance, the next step is to divide and subdivide the whole work into smaller homogenous units so that the same may be assigned to different individuals. For example, the General Manager of a big business concern cannot look after the various activities of the different departments. He may, therefore delegate some of his functions to the Departmental managers, who in turn may delegate some of these responsibilities to Deputy Managers. Thus, in devising an organisational structure, it is important to divide the entire work into manageable units. It has rightly been said that the

job constitutes the basic building block in building up an organisational structure.

8.7.2 Decision Analysis

It is the second major tool to find out what is needed. As regards decision analysis, Peter Drucker has emphasized four basic characteristics, viz., (i) the degree of futurity in the decision; (ii) the impact that decision has on other functions; (iii) the character of the decision determined by a number of qualitative factors, such as, 'basic principles of conduct, ethical values, social and political beliefs etc.'; and (iv) whether the decisions are periodically recurrent or rates as recurrent decisions may require a general rule whereas a rate decision is to be treated as a distinctive event. He adds that "a decision should always be made at the lowest possible level and so close to the scene of action as possible." Thus, such an analysis will show what structure of top management the enterprise needs and what authority and responsibility different levels of operating management should have.

8.7.3 Relations Analysis

In the case of relations analysis, the traditional tendency is to define the job of a manager in terms of the activity he heads, i.e., only downward. Drucker emphasizes that "that first thing to consider in defining a manager job is the contribution his activity has to make to the larger unit of which it is a part." Thus, the upward relationship must be analysed and established first, and the sideways relations must also be analysed.

8.8 NATURE OF ORGANISATION

8.8.1 Common goals

Every organisation is established to accomplish some common goals. The organization structure must reflect these objectives. Organisation is bound by some common purpose.

8.8.2 Rules and regulations

Every organisation is formed under the rules and regulations for the orderly functioning of people.

8.8.3 Division of labour

In an organisation total work is divided into sub-functions. This is necessary so that the right job is done by the right man to avoid time wastage and resource wastage.

8.8.4 Communication

Every organisation has its channels of communication. These are necessary for mutual understanding and co-operation among the members of the enterprise.

8.8.5 Environment

Organisation functions in multivariant environment consisting of economic, social, political, legal and technological factors. So when the structure is designed it is kept in mind that the environment is ever changing.

8.8.6 People

There are several groups of people activating in the organisation therefore activity groupings and authority provisions must take into account the limitations and customs of people.

8.8.7 Co-ordination

Organisation's different activities and different parts are coordinated so as to bring out it as an integrated whole.

8.8.8 Authority structure

In an organisation there is an arrangement of positions into graded series. Authority and responsibility of every position is defined.

8.9 ORGANISATION AS AN ART

Art is an application of knowledge and skills. Therefore, business organisation is an art as one has to apply his skills and knowledge in solving several problems of business in order to achieve its goals. Organisation is creative like an art, as it is concerned with getting the work done by other, by the art of motivating, controlling, coordinating of one activities.

8.9.1 Organisation as a Science

Science is the systemised body of knowledge. It believes in practicals and establishes cause and effect relationship. Its principles have universal acceptability and these principles are evolved on the basis of continued observation.

Organisation is viewed as a science as it is an organised body of knowledge. It is built up by the management practitioners, thinkers and philosophers. It also has certain principles developed after continuous observation. But at the same time like Physics, Chemistry it is an inexact science because its principles are not universally accepted. This is because it deals with the human beings whose behaviour cannot be predicted. Therefore, we call organisation is 'behaviour science'.

8.9.2 Individual and group behaviour

Understanding human behaviour is an important task of management. A manager has to deal with a large number of persons, both inside and outside the organisation. Inside the organisation he has to interact with his subordinates on the one hand and with superior officials, on the other hand. He has to get things done through and with his subordinates as per directions of the superior bosses. Besides dealing with the superior and the subordinate, he has to deal with a large number of people including suppliers, customers, competitors, trade union leaders, correspondents, legislators, public officials, etc. In order to achieve his mission and objectives with and through others he must understand why people behave as they do? Why people act, react and respond as they do? Why people resist to change as they do? Such an understanding of the human behaviour will assist him a lot in going through the mill and ultimately achieving the planned target.

It is not only the behaviour of the individual members but also of the groups that should be studied carefully, groups exist-in every organisation and they effect the behaviour of their members. They do not affect the behaviour of their members, but have also an impact on other groups and the organisation as a whole. Human behaviour is goal-oriented. Whatever one does, he does it with a view to fulfill certain needs and desives. Need and desires create mental tension and discomforts and the tension comes to and end when only the needs are satisfied; otherwise it grows and may result is disharmony and even disorganisation. When the goal is not achieved, frustration may creep in and one may be compelled even to give up the goal or change the path of the goal or substitute another goal.

Behaviour is influenced not only by the needs of the individuals and the groups, but also by the manner in which people handle their needs. The same need may lead to different responses; it may be met by different satisfiers and similar behaviour may be adopted for the satisfaction of different needs.

8.9.3 Formal and informal relationships

Formal and informal relations among individuals and groups are an integral part of social behaviour in organisation. It is through these relationships that work-related activities are organised, performed, coordinated and controlled. Formal relationship are established in an organisation through authority, responsibility, relations, definitions of jobs and roles, stratification of status in hierarchy and required patterns of interaction, communication and coordination. Certain indicators of formal relationships are : (i) defined jobs and roles, (ii) job-descriptions, (iii) authority-responsibility relationships, (iv) written communication, (v) rules and policies, (vi) penalties for violating rules, (vii) formal orientation of new employees and (viii) formal training programmes.

Informal relationships emerge among employees as a result of required interactions. Informal relations play an important role in the perfomance of organisational functions as formal relations. A simple example is very much illuminating in this connection. Mr. X, the principal of a college, is in need of a water cooler for his institution. He has to submit an application to the Directorate of the Collegiate Education and wait till the administrative sanction is received. This is the formal procedure, but if he has informal relations with the Director, he may simply phone the Director, secure his acceptance and may go ahead. All this places much reliance on informal relations and patterns of cooperation.

We may now discuss the influence of authority, status, recognition and security on formal and informal relations.

8.9.3.1 Authority and Relationships

Formal authority establishes formal relations through establishing authority-responsibility relations. Because of the limitation of formal authority that it is weakened through frequent use of

sanctions, managers use influence and persuasion in order to get the cooperation of their subordinates for task performance.

8.9.3.2 Status and Relationships

The term status refers to the social ranking of a person in relation to others in a group situation. People occupying higher positions in organisational hierarchy carry more authority and, therefore, more formal status as compared to others. Wider the status differences between any two individuals, more the relations tend to be formal. Greater the face-to-face interaction among two persons or groups, more the relations tend to be informal. Organisations aiming at building healthy informal relations should deemphasize status differences.

8.9.3.3 Security and Relationships

Security is one of the most important personality needs. Every employee depends on his organisation for the satisfaction of his social, economic and psychological needs. This dependence generates in him a sense of insecurity. To the extent, a person feels insecure, he feels emotionally blocked in building healthy informal relationships with others. Therefore, a manager desirous of building healthy informal relationships with his subordinates, should aim at their feeling of security.

8.9.3.4 Recognition and Relationships

Recognition is again an important ego need. Most of us seek recognition as a person with abilities, competence, integrity and responsibility. To the extent, a manager succeeds in extending recognition to his subordinates as individual with unique abilities and socio-emotional needs, he can build healthy informal relationships with them.

8.10 GROUP DYNAMICS

Shaw defines 'Group' as 'two or more persons who are interacting with one another in such a manner that each person influences and is influenced by each other.' Groups are formal as well as informal. Group Dynamics refers to the 'Forces operating in groups'. It is concerned with the interactions and forces between group members in a social situation. Group dynamics is the field of equity that deals with the nature and development of small groups, interactions among members, and group and intergroup behaviour. The basic assumptions underlying the study of group dynamics are : (i) groups are inevitable and ubiquitous, (ii) groups mobilise powerful forces that produce effects of utmost importance to individuals, (iii) groups may produce good or bad consequences on the organisation, and (iv) correct understanding of group dynamics permits the possibility that desirable consequences from groups can be deliberately enhanced.

8.10.1 formal and informal groups

In every organisation there may be two types of groups on the basis of structuring, viz., (i) formal, and (ii) informal. Formal groups are created to carry out some of specific work or meet some goals of the organisation. A formal group is a legitimate submit of the organisation which is duly established. Committees, project teams, task forces, small departments or cells are all examples of a formal group.

Informal groups, on the other hand, are created in the organisation because of operation of social and psychological forces operating at the work-place. Informal groups develop apart from officially prescribed plan of the organisation. They arise spontaneously on the basis of friendship or some common interest which may or may not to be work related. There are informal groups of operatives. Informal groups represent the pattern of interpersonal and intergroup relations that develop within the formal organisation, e.g., friendship groups and cliques. Informal organisation tends to develop when formal organisation proves to be inefficient or when it fails to satisfying important psychological and social wants and aspirations of the members in the work environment.

8.10.2 Difference between Formal and Informal Group

Essential points of difference between formal and informal groups are as follows :

8.10.2.1 Origin

Formal groups are created deliberately and consciously in the organisation by the framers of the organisation, but informal groups are created due to socio-psychological forces operating at the work-place.

8.10.2.2 Purpose

Formal groups are formed for achieving the legitimate objective of the organisation, but informal groups are created by the members of the organisation for their social and psychological satisfaction.

8.10.2.3 Size

Formal groups may be quit large in size, but informal groups tends to be small in size.

8.10.2.4 Nature of groups

Formal groups are stable and may continue for a long period, but informal groups are quite unstable in nature.

8.10.2.5 Number of groups

The number of both formal and informal groups may be quite large, but generally informal groups are more than the formal groups. They may also be overlapping of membership.

8.10.2.6 Authority

In formal groups, the authority flows from higher to lower levels; in the informal groups all members are equal. In informal organisations, some may command more authority by virtue of their personal qualities.

8.10.2.7 Behaviour of members

The behaviour of members in the formal groups is governed by formal rules and regulations, but in informal groups the behaviour of the members is governed by norms, belief and values of the groups.

8.10.2.8 Communication

In formal groups, the media of communication is prescribed, but in informal organisations the communication pass through informal channels.

8.10.2.9 Abolition

Formal groups can be abolished at any time but it is very difficult to abolish informal groups. Since the informal groups are the creation of natural desire of human beings to interact, management does not have any control over them.

8.10.2.10 Leadership

Formal organisation has official leadership, informal organisation has its own leaders, own goals and own standards.

8.10.2.11 Types of Informal Groups

Mayo and Lambard have classified informal groups into three categories-natural, family and organised. The natural groups does have very little structure; the family group has regular members who exert marked influence on the behaviour of members and the organised groups have some acknowledged leaders and a more consistent structure.

Leonard R. Sayles has identified four types of groups according to their characteristics. apathetic, erratic, strategic and conservative. Apathetic groups are least active, have fewest grievance and do not engage in concerted action against management or unions. Such groups are characterised by disperasal and unaccepted leadership, lack of cohesiveness, internal disunity and conflict and suppressed dissatisfaction. Erratic groups are characterised by rapid inflammability, poor control, inconsistent behaviour, centralised autocratic leadership and union formation activites. Strategic groups are characterised by well-planned and consistent grievances. They act as shrewd, calculating groups that put continuous pessure on management to attnet to their problems. Conservative groups are characterised by moderate internal unity, limited pressure for highly specific objectives and a sense of self-assurance.

8.10.2.12 Functions of Informal Groups

Informal organisation exist because they perform certain desired functions for their members. Informal groups help their members in satisfying the following needs through their groups membership; (i) affiliation need, (2) needs for establishing a sense of identity and enhancing self-respect, (3) security need, (4) need to validate their beliefs and values, (5) need for help in solving work problems, (6) need to get information, and (7) need for support for individual innovation and originality.

8.10.3 Advantages of Groups

The different advantages of groups may be outlined as follows : (1) Groups create a pleasant and satisfying environment for its members. (2) All the needs and desires of the members are easily satisfied. (3) Work-performance becomes easier due to mutual cooperation. (4) Groups provide psychological support to their members. (5) Communication is facilitated. (6) It establishes group standards of performance. (7) Need for close supervision is also reduced. (8) Groups lead to organisation and development and facilitate research and innovation. (9) Group cohesiveness reduces turnover and absenteeism. (10) It develops groups spirit and pride. (11) Members of highly cohesive groups feel less nervous and express less anxiety. (12) Grapevine complements and supplements official communication, and (13) groups help protect their members from outside pressure.

8.10.4 Disadvantages of Groups

Some of the disadvantages of informal organisations are as below : (1) Groups often set production norms below the physical capabilities of their members. (2) Groups insist on the observation of the group norms. (3) Group cohesiveness impedes acceptance of new employees. (4) Groups resist innovation and change in work methods. (5) Groups often hide their innovations from management and use it in their own interest. (6) Groups often oppose the management policies and procedures. (7) Groups often spread rumours affecting the smooth working of the organisation (8) Groups often demand a price for co-operation. (9) Since the groups try to meet the social needs of their members, there is a natural tendency to produce role conflict. (10) Jurisdictional disputes among groups create problems for management.

8.10.5 Management of the Group

The management must recognise that groups are a fact of life and cannot be done away with. A manager can succeed in utilising groups for enhancing his effectiveness by gaining an understanding of their goals. Structure and processes. The following measures are suggested as a guideline to managers for achieving groups cooperation and support to management goals : (1) Integrate management goals with groups goals, (2) Involve groups in decision-making process, (3) Make use of the group method of supervision, (4) Resolve inter-group conflict by (i) Locating a common enemy, (ii) bringing sub-groups of competing groups into interaction with each-

other, (iii) locating a super-ordinate goal, and (iv) using laboratory training methods, and (5) Let employees feel that management accepts and understands informal organisation. The best approach would be to recognise the existence of informal organisation with formal one.

8.10.6 inter-group behaviour and conflict

When groups constituting two or more persons work together for the achievement of a common objective, they interact in such a way that each group influences, and is influenced by other groups. In short, the groups have their impact on the whole organisation. The intergroup interaction may lead to co-operation or conflict. Well, if there is co-operation, it will lead to healthy growth of the organisation. However, if group interaction produces conflicts among the group, it may lead to undesirable consequences. Hence no stone be left unturned to prevent conflicts.

8.10.7 Causes of Inter-group Conflict

the term 'conflict' may be regarded as the disagreement or hostility between individuals or groups in the organisation. It may even mean rivalry or competition. Factors leading to inter-group conflict may be summarized as follows :

8.10.7.1 Goals and their incompatibility

Inter group conflict arises because of goal incompatibility, that is, goals attainment by one group may prevent or reduce the level of goal attainment by one or more other groups. The conflict between the marketing and the production departments in business organisations is a classic example of such conflicts.

8.10.7.2 Resource sharing

Conflict of this type arises due to discrepancy between aggregated demand and available resources. Each part of the conflict has an interest in making the total resources as large as possible and at the same time they also aspire for having the lion's share. Labour management conflict arises due to this factor. Such conflicts take place on the quantum of wages, amenities, working conditions and other related matters.

8.10.7.3 Task relationship

Conflicts arise due to this factor when a group exceeds its authority. For example, if the superior officers act in excess of the advisory roles assigned to them, the conditions for conflict exist.

8.10.7.4 Absorption of uncertainty

Uncertainty is the gap between that is known and what needs to be known and what needs to be known to make correct decisions. The conditions for conflict exist if uncertainty absorption by one group is not in accordance with the expectations of the other groups. For example, if the rules framed by the accounting department appear

to be inadequate or inefficient by the production or the sales department, there is a chance for conflict between the two groups.

8.10.7.5 Attitudinal sets

If the group relations begin with the attitudes of distrust, secrecy and competitiveness, there is a possibility of various factors of group relationship being emphasized in negative way, consequently leading to conflicts.

8.10.8 Conflict Management

Business management should function in such a way so as to maximise coordination of human resources and minimise conflict. Efforts for conflict management may be divided into two groups : (i) preventive measures and (ii) curative measures. The following measures be may be included under the first caption : (a) Development of effective leadership, (b) Participative decision-making, (c) Two-way communication system, (d) Improvement in interpersonal relationship, and (e) revision for facilities and opportunities to develop informal groups. The curative measures include the resolution of conflicts when they take place and become dysfunctional in the organisation. According to March and Simon, an organisation may react to conflict by (i) problem-solving, (ii) persuasion, (iii) bargaining and (iv) politics.

8.11 ORGANISATION DEVELOPMENT

Organisation Development (O.D.) focusses our attention on innovation and planned change in the organisation. Warren Bennis has defined O.D. as follows : "O.D. is a response to change, a complex educational strategy intended to change the beliefs, attitudes and structure of organisations so that they can better adapt to new technologies, markets and challenges." In the words of Wendell L. French and Cecil H. Well : "Organisation Development is a long-range effort to improve an organisation's problem-solving and renewal processes, particularly through a more effective and collaborative management culture-with special emphasis on culture of formal work team-with the assistance of a change agent, or catalyst, and the use of the theory and technology of applied behavioural science including action research." R. Beckhard defines it as a change strategy which is : (i) planned, (ii) organisation-wide, (iii) managed from the top, to (iv) increase organisation effectiveness and health through, (v) planned interventions in the organisation's processes, using behavioural science knowledge. The three main objectives of O.D. are : (1) Improvement in the performance of the organisation, (2) Improvement in the ability of the organisation to adapt to its environment, and (3) Improvement in inter-personal and inter-group behaviour to secure teamwork.

8.11.1 Characteristics of O.D.

1. It is an educational strategy for bringing planned change.
2. It is related to real problems of the organisation.
3. Change agent applying OD techniques for change is external to the forms of consultants.

4. There is a close working relationship between change agents and the people who are being changed.
5. The change agents share a social philosophy about human values.
6. OD seeks to build problem-solving capacity by improving group dynamics and problem confrontation.
7. OD reaches into all aspects of the organisation culture in order to make it more humanly responsive.
8. OD and Management Development are complementary rather than conflicting.

8.11.2 Steps in O.D.

The following methods can lead to better organisation climate (1) Increasing inter-personal trust and support among employees, (2) Decision-making on the basis of competence, (3) Resolve the conflict in such a way that the final outcome is not a win lose situation but a win-win situation, (4) Developing a sense of belonging amongst the employees, (5) Developing team spirit based on mutual co-operation and not competition, (6) Creating favourable climate for human development, (7) Developing effective communication between men and boss, (8) Increasing self-direction for personnel within the organisation.

CHECK YOUR PROGRESS

2 Write some difference between formal and informal group

.....
.....
.....

SUMMARY

Organisation is the foundation upon which the whole structure of management is built. It is the backbone of management. Without organizing managers cannot function as managers. Organization is concerned with the building, developing and maintaining of a structure of working relationships in order to accomplish the objectives of the enterprise. Organisation means the determination and assignment of duties to people, and also the establishment and the maintenance of authority relationships among these grouped activities. 'Organisation system of co-operative activities of two or more persons'. The classical writers have viewed organisation as a machine and human beings as different components of that machine. It has its origin in the writings of Taylor. However the main ideas of this theory have been developed by Mooney, Brech, Allen and Urwick. According to classical approach, where organization is treated as machine, the efficiency of the organisation

can be increased by making each individual efficient in it. This theory views the organisation as a system and studies it in its totality as a complex of human interrelationships. Scott observes that "the distinctive qualities of modern organisation theory are its conceptual-analytical base, its reliance on empirical research data and above all, its integrating nature. Organisation structure is an indispensable means; and the wrong structure will seriously impair business performance and may even destroy it. Organisation structure must be designed so as to make possible to attainment of the objectives of the business for five, ten, fifteen years hence." Organisation is viewed as a science as it is an organized body of knowledge. It is built up by the management practitioners, thinkers and philosophers. It also has certain principles developed after continuous observation. In every organisation there may be two types of groups on the basis of structuring, viz., (i) formal, and (ii) informal. Formal groups are created to carry out some of specific work or meet some goals of the organisation. A formal group is a legitimate subset of the organisation which is duly established. Committees, project teams, task forces, small departments or cells are all examples of a formal group.

Informal groups, on the other hand, are created in the organisation because of operation of social and psychological forces operating at the work-place.

QUESTIONS

1. Explain the concept of organisation.
2. What do you understand by "An Organisation"?
3. Define organisations.
4. What are various theories of organisation? Explain each.
5. What are formal and informal organisation?
6. What is the importance of organisation?
7. Explain the organisation process.
8. On what grounds analysis of organisation can be done?
9. Explain the nature of organisation.
10. Organisation is an Art or Science. Justify.
11. What are the advantages and disadvantages of groups?
12. Differentiate between formal and informal groups.
13. What are the characteristics of organisational development?

9. MOTIVATION

- 9.1 WHAT IS MOTIVATION?**
- 9.2 MEANING OF MOTIVATION**
- 9.3 KINDS OF MOTIVATION**
- 9.4 MC GREGOR'S THEORY X AND THEORY Y**
- 9.5 CO-ORDINATION : COMPANY'S CULTURE**
- 9.6 COMPANY COMPENSATION AND BENEFITS**
- 9.7 NEED-HIERARCHY THEORY OF MOTIVATION**
- 9.8 MOTIVATIONAL TECHNIQUES**
- 9.9 FINANCIAL AND NON-FINANCIAL INCENTIVES**

OBJECTIVE

After this unit you will be able to explain

- Understand meaning & kinds of motivation.
- Comprehend theories & techniques of motivation.
- Able to motivate others (Motivating Skills)

MOTIVATION**9.1 WHAT IS MOTIVATION?**

The term motivation is derived from the Latin word 'movere' (to move). Motivation is defined as the intrinsic state that energizes, directs and activates the behaviour of the individual towards attainment of goals.

The employees ability to work and second, the employees willingness to work. Most of the individuals who are inducted in the organisation are having sufficient ability to work. This ability can be further enhanced by training and experience and thus can be managed without much effort. However, it is difficult to manage the employees willingness to work because it involves change in attitudes and behaviour towards work.

For the last three decades or so research on motivation has escalated dramatically and even today issues concerning work motivation continues to be an elusive factor largely because every human problem, a manager faces in organisation has elements of motivation. In manpower intensive service industries like banking if you ask any manager what is the biggest problem he faces in co-ordinating his day-to-day operations in his work station then more of ten than not the likely answer will be I wish I had a better motivated group of employees working for me. The problem of motivation is becoming more apparent and visible nowadays because of stiff economic competition in the market. In this regard, the thorough understanding of the concept and nature of motivation is considered as one key to successful management. With regard to motivation a discussion on a sample of questions which perturbs the executives of the banks today is very much needed. For instance the most potent question that can be asked pertains to whether a manager is capable of bringing about long lasting motivation in his workforce or not? Another important question relates to how can employees be motivated to direct their energies towards work?

9.2 MEANING OF MOTIVATION

Motivation is productivity factor in industry. It is the sum total managerial science. The most important task of the management is to get the work done by the subordinates and achieve results. Getting the work done depends mainly on whether a person has been motivated to do it. Motivating a worker is to create a need and a desire on the part of a worker to better his present performance.

This will mean to do anything beyond just what he is required to do. This can be done by creating in him a sense of responsibility and feeling of special interest in his work. Motivation concerns itself with the will to work. It seeks to know the incentives for work and tries to find out the ways and means whereby their realization can be helped and encouraged. Motivation has been defined by Michael J. Jucius as; "the act of stimulating someone or oneself to get a desired course of action, "to push the right button to get a desired reaction."

9.3 KINDS OF MOTIVATION

Motivation can be either negative or positive. Punishments, reprimands, fear of loss of job are method where people work in fear. They will tend to produce minimum enough to get by safely. Whereas positive motivation makes people willing to do their work in the best way they can and improve their performance. Now the real problem is how can this be achieved? There are so many opinions written and spoken and things said and done about it. Success has been invariably found where certain basic principles of human relations are followed. This might have been followed consciously or unconsciously. Some executives call it and prefer to call it as their psychological or clinical hunch. Whatever may be the case, executives should know :

- (a) Facts of individual differences. Each man is different from other. At the same time a person is not a static thing. As he is in process of continuous change throughout his life, it is necessary to study the man as a whole and keep studying him in order to help to get the maximum satisfaction out of work.
- (b) Though employees are different individually, they all want the following things from the job : (i) Recognition as an individual, (ii) Job security, (iii) Freedom from arbitrary action, i.e., fairness in management policy-and voice in matters affecting them, (iv) Opportunity to advance, (v) Meaningful task-why of job and where it fits into the larger picture of production, (vi) congenial associates, (vii) Satisfactory working conditions, and (viii) Fair wages.

To what extent the above aspects improve the morale and motivate people, has been studied by various psychologists and social scientists in all progressive countries. It is surprising to note that financial wants is not considered to be the most important factor in motivation. It has got its own values, but after sometime and improvement in living standard, it ceases to work as motivating factor. It may be argued that in developing countries like India talks of any other motivation than wage incentive are futile and out of place. This is more a matter of feeling and not a fact. Considerable number of strikes and labour unrest is owing to other than wage factor. In the absence of an outlet for venting their grivances, workers express their inarticulate dissatisfaction through gneral demands of wage rise.

There are numerous examples where labour unrest exists in spite of comparatively higher wages and better working conditions. There are other instances of most cordial relations with very bad working conditions and low wages. This calls for revised thinking on the whole problem of motivation and morale in industry.

9.4 MC GREGOR'S THEORY X AND THEORY Y

Douglas Mc Gregor has classified the basic assumptions regarding human nature into two parts and has designated them as Theory X' and Teory Y'.

9.4.1 *Theory X*

This is the traditional theory of human behaviour. In this theory Mc Gregor has made the following assumptions about nature :

1. Management is responsible for organizing the elements of productive enterprises-money, material, equipment, people-in the interst of economic ends.
2. With reference to people it is a process of directing their efforts, motivating them, controlling their actions, modifying their behavior in order to be in conformity with the nees of the organisation.
3. Without this active intervention by management, people would be passive event resistant to organisational needs. Hence, they must be persuaded, rewarded, punished, and properly directed. It is the task of the management. We often sum it up by saying that management consists of getting things done through other people.
4. The average human being has an inherent dislike of work and will avoid it if he can.
5. He lacks ambition, dislikes responsibility and prefers to be led.
6. He is inherently self-centered, indifferent to organisational needs.
7. He is by nature resistant to change.
8. He is guillible not very bright, the ready dupe of charlatan and the demangogue.

It is worth nothing that out of all the eight assumptions, only the last five deal with human nature and the first three relate to managerial actions. McGregor believes that there is a consideratble change in behavioural pattern. Theory X holds that efficiency in an organisation will be high when authority in the organisation is clear and flows from the superior to subordinates without any reservation. According to this theory an individual should be given the task for which he is best fitted and there shold be very close supervision of his work. Theory X is built not the assumption that the subordinates can be hired and fired, used and discard like any other commodity by the management. It represents the autocratic managerial style. The management adopted the carrot and stick technique for human motivation. The leadership practices attributed to the scientific. management advocates are thought to be

based on the theory X assumptions. Those who believe in theory X view management as a highly directive behaviour. A manager, according to them must take effective steps to direct the behaviour of his subordinates.

9.4.2 Theory Y

The assumptions of Theory Y, according to McGregor, are as follows :

1. Work is as natural as play or rest, provided the conditions are favourable. The average human being does not inherently dislike work.
2. Authoritarian methods are not the only methods for getting things done. External control and the threat of punishment are not the only means for bringing about efforts towards organisational objective. Man can exercise self-control and self-direction in the service of objectives to which he is committed.
3. Commitment to objectives is a result of the rewards associated with their achievement. The most significant of such rewards e.g. the satisfaction of ego and self-development needs, can be the direct results of effort directed towards company objectives. People select goals for themselves if they see the possibility of some kind of reward that may be material or even psychological. Once they have selected their goal they will pursue it even without close supervision and control.
4. The average human beings, under proper conditions, do not shirk responsibility, but learn not only to accept responsibility but also to seek it.
5. The capacity to exercise a relatively high degree of imagination, ingenuity and creativity in the solution of organisational problems is widely, not narrowly distributed in the population.
6. Under conditions of modern industrial life, the intellectual potentialities of people are only partially utilized. As a matter of fact, men and women have unlimited potential.

According to Theory Y, if the subordinates are treated like adults and allowed to exercise self-control over their activities, it will satisfy their ego and social needs as well as their bread and butter requirements. Theory Y emphasizes that management is not merely a direction of things; it is an act of 'making-men' and 'creating opportunities'. Indeed, management is a process of actuating man for greater and better work; it is the process of realizing potential, removing obstacles, encouraging growth and providing guidance. The principal task of management is to arrange organisational conditions and methods of operation so that people may achieve their own goals best by directing their own efforts towards organisational objectives. In short, Theory Y advocates the idea of decentralization of authority. Job enrichment (and not specialisation) should be the aim in structuring an organisation. Last, but not the least, Theory Y believes in 'Participative

Management', i.e., people must be given some voice in decisions that effect them. It is a common experience of all management experts that participative and consultative management is more successful and effective than a highly directive type of management.

9.4.3 Comparison of Theories X and Y

1. Theory X assumes human beings to be inherently distasteful towards work but Theory Y assumes that work is as natural as play or rest.
2. Theory X emphasises that people do not have ambitions and they try to shrink responsibility but the assumptions of Theory Y are just the reverse.
3. Theory X assumes that people in general have little capacity for creativity but according to Theory Y the capacity for creativity is widely distributed in the population.
4. According to Theory X, people lack self-motivation and require to be externally controlled and closely supervised in order to get the maximum output for them, while in Theory Y people are self-directed and creative and prefer self-control.
5. Theory X emphasizes upon the centralisation of authority but Theory Y emphasizes decentralisation and greater participation in the decision-making process.

CHECK YOUR PROGRESS

1. Write the meaning of motivation

.....

.....

.....

.....

.....

9.4.4 Herzberg's motivation-hygiene theory

In late fifties, about two hundred engineers and accountants were interviewed at Pittsburg and were asked to relate the elements which made them happy while working. These people were asked to describe a few past job experiences in which they felt exceptionally good or exceptionally had about their jobs. An analysis of their answers revealed that feeling of unhappiness and happiness both were related to the environment in which they worked. He concluded that there are two set of conditions. The first type of conditions were described as hygiene factors. Absence of hygiene in the organisation made them unhappy. The other conditions called as motivational factors were absent in the organisations. Any increase in these factors will satisfy the employees and help to improve their performances.

Maintenance or hygiene factors are called such because they are necessary for reasonable level of satisfaction. Absence of these factors will dissatisfy the people on the other hand their presence and addition of more and more of these factors will not help in motivating the satisfied people. Factors necessary for maintaining a reasonable level of satisfaction in employees are :

1. Salary
2. Working conditions
3. Job security
4. Work relations with subordinates
5. Company policy and administration
6. Technical supervision
7. Inter-personal relationship with peers
8. Inter-personal relationship with subordinates
9. Inter-personal relationship with supervisors
10. Status
11. Personal life.

Presence of motivational factors build high motivation and job satisfaction but their absence do not cause dissatisfaction. At the same time increase in these factors will be essential for increasing motivation of employees. Managers did not realise the importance of motivating factors. The employees are motivated by the content of the job. The satisfaction which an employee would derive from the job will certainly go to increase his output. The factors of motivation are:

1. Opportunity for personal growth
2. Achievement
3. Recognition
4. Work itself
5. Advancement and
6. Responsibility

Critics

Herberg's theory proved and showed the managers that by simply improving wages and work-conditions one cannot achieve higher performance. The key to job satisfaction and high performance lies in job enrichment. This theory helped in improving manager's basic understanding of human behaviour. Earlier job satisfaction and dissatisfaction were viewed as opposite ends but Herberg proved that dissatisfaction and satisfaction are interdependent rather than being at opposite ends. Therefore managers should try to reduce dissatisfaction arising out of hygiene factor and building up the satisfaction from motivating factors.

Apart from this his theory had following critics :

1. Critics says that this theory is not universally applicable because other researchers have drawn different results from similar studies. They say that a small sample of 200

accountants and engineers is not the representative of the work force in general.

2. The says that there is no link between satisfaction, motivation and performance. This theory puts too much of stress on satisfaction rather than on performance level.
3. The theory ignores the dominating influence of the situational variables. The distinction between maintenance factors and motivating factors is not fixed. What is maintenance factor for a worker in USA may be motivator for our indian workded for example salary. Motivational and maintenance facotrs operate in one direction but also partly in other direction.

9.4.5 Theory Z: Theory of William Ouchi

Criticising the contradictory assumptions under Theory X and Theory Y, Ouchi has proposed another theory of human behaviour and he has designated it as Theory Z. According to Ouchi the primary task of every manager is to produce goods or services at prices which the consumers are able and willing to pay. With this objective in view, he must direct the efforts of those associated with him. Ouchi further indicates that it would be possible under two conditions, viz., (1) Every member of the organisation must know the organisational goals precisely and the contribution which his attempts are making towards the realization of goals; and (2) Each and every member of the organisation should be confident that the realization of organisational goals is going to affect his need satisfaction positively. In short, Theory Z takes into account the account the organisational variables in shaping the behaviour of individuals. The advocates of this theory believe that a particular individual is likely to behave differently in different organisational conditions. From this point of view, the thory present a more realistic picture of human behaviour. In other words, the success of any organisation depends ultimately on the morale of all those engaged in it. If the management evolves appropriate organisation which will satisfy both the needs of the job and needs of the people, we shall have maximum motivation and productivity.

William Ouchi developed Theory Z after making comparative study of Japanese and American management practises. Theory Z is the new way of viewing the essential nature of man and the factors that motivate war. The managerial techniques of Japan are of great interest as they are different from all those developed in western countries. Theory Z has oriented from Japanese management practises. Japanese managers makes better use of human capital. The rate of increment in productivity in Japan is roughly 2-3 times that of American firms. As compared to American companies in Japan absentism has been low, organisational commitment is high and turnover rate is half. Management experts after viewing Japanese 'Industrial Miracle' developed Theory Z. Five major

dimensions in which Japanese differs from Americans and element of Theory Z are :

Essentials

The five elements of Motivation are :

(1) Concern or socialisation; (2) Co-ordination; (3) Long-range human resource development; (4) Total employee group involvement in problem solving; (5) attractive company compensation and benefits. A close look at each of these elements provides special insights into why and how Japanese management has succeeded so admirably in the "generation and direction of human energies."

Concern or Socialisation

The cornerstone of Japanese Company philosophy is that it raises the aspirations, ideals and beliefs of those associated with the company which in turn create a certain set of attitudes, which motivate the managers, supervisors, and employees to strive for achieving goals that are high, noble and fulfilling. This is not a management gimmick, but a natural phenomenon of the Japanese culture, which expects and encourages people to cooperate and collaborate together in groups to achieve the goals of the society and the nation. As a consequence people respond to the strong vibrant company philosophy.

One of the major strategy used by Japanese firms is organisations concern is oriented towards the satisfied life of people and employees.

An exmple : let us look at company philosophy of the largest electric company in Japan, Matsushita Electric, whose brand name is "National" and how it raises the sights of its employee to a higher plane and purpose :

"Matsushita Electric has close ties with society, for great expectations are placed on our business achievements by the public. It is here that the reason for our company's existence is to be found. Regardless of whether it is explicitly stated or not, society expected something of us. It can be said, in other words, that Matsushita has a tacit agreement with the public. This agreement is invisible and inaudible, and yet, is to be understood and fulfilled by us as the supreme objective of our company.

"In order to fully understand and fulfil this agreement our company has established a basic business policy. It is important that all employees use the principles set forth in this policy as a basic guideline in making decisions and in our daily activities. It is the obligation of employees to understand and observe the company's basic business policy. As long as we interpret and use this policy, taking into consideration the demands of the time, and as long as we produce high quality produces and make them available to the public, our activities will always be appreciated by society. This will enable our company to continue growing and lead it closer towards fulfilling its important duties as a public institution. Matsushita Electric is a company which derives unbounded pleasure from these

efforts and strives everyday to maintain a fresh progressive management. The more conscious our employees become of this duty, the more successful our company will become in achieving excellent results."

Then the company states its philosophy thus, under the title of social Responsibilities of Matsushita :

"It is stated in our basic business principles that our goals are to recognise our responsibilities as industrialists to foster progress, promote general welfare of society, and devote ourselves to the further development of world culture. In other words, we are serving the public through the production and sales of electrical appliances. We should view the basic business principle of all of our work as being to serve the public and contribute to the society.

"Just as farmers contribute to society through the production of electrical appliances. The more we give to society, the more society will prosper. At the same time, the more we contribute to society, the greater our own rewards, in the form of income and happiness, will become.

"In short, we are rewarded through our service to society. Those making great contributions will likewise be greatly rewarded. Needless to say, we should not work for the purpose of being rewarded. Reward should come as the result of our contributions. If we do business with the thought in mind of serving society, our company will soon expand throughout the world and be recognised in this concept. All employees should sincerely and modestly think about what they, in their way, can do to contribute to this endeavour. The word 'modestly' which I have mentioned here means that things will be achieved in a proper manner if we evaluate ourselves correctly and make judgements with a modest attitude. During more than six decades of Matsushita's history, our expectations have been fulfilled almost completely on all occasions. In fact, the results of the first five year plan rose above our expectations. This was by no means a matter of mere chance. It shows that a plan made with sincerity, a modest attitude and honest judgment will never fail. Our company does not exist for the sake of our own glory and gain but for the sake of society. In other words, we are doing business according to the higher principle of serving society. I believe that this business principle will continue for ever and that we should, at the same time, endeavour to make the objectives of this principle become a reality."

9.5 CO-ORDINATION : COMPANY'S CULTURE

The Japanese tradition, culture and social mores leave significant impression on the evolution of a distinct corporate culture, which encourages an unique form of co-operation and collaboration between management and labour in the interests of the economic health and welfare of the company, while discouraging ruinous conformation attitudes that we have become familiar with British, Australian and even American pattern of industrial relations. Perhaps the most important factor is that there is a certain

amount of loyalty and commitment towards the employees on the part of the company and its management and similarly a tremendous commitment and loyalty on the part of the employees to their company. This is a cultural phenomenon, which most observers in the West find it astonishing. The Japanese society expects this kind of relationship in a company and would grow upon a hire-and-fire-policy of management. The loyalty and commitment factor has great impact on the morale and motivation of the managers and workers, terms which have very tangible results both for the company and workers, in terms of productivity, problem solving, decision-making and profits, more important, adjusting to technological changes.

There are many other manifestations of a distinct company culture pervading the lives of workers, supervisors and managers. They sing the company song. They live in company dormitories, eat in company canteens together, go on company outings and picnics; play golf or tennis, do calisthenics on company facilities, travel together, work together in QC circles, study groups, task forces, committees apart from the office, and production floor. There is a constant intercourse and exchange among employees and managers, which encourages and further builds commitment and loyalty to each other.

An example : In Nissan, the makers of Toyota, more than 13,000 unmarried employees live in single rooms in company dormitories. About 3,500 families live in Toyota apartments and for those who choose to buy their own homes, the Toyota Home Finance Scheme provides loans at well below the bank's going rate. The Toyota Coop established back in 1940s has nearly 90 stores all conveniently situated near company housing. For staff holidaying at home, there are company resorts and more than 200 inns and hotels where Toyota workers can claim huge reductions. In sickness as in health, the company is at hand. The 400 bed Toyota General Hospital has a staff of 26 doctors and 122 nurses providing the kind of health care NHS patients in Britain can no longer take for granted. There is an emergency and accident unit, a maternity unit, and theaters equipped to deal with everything from a simple appendectomy to complex brain surgery-all free.

While the company keeps one eye on the present workforce, it keeps another just as firmly on the future. Just a stone's throw from the head office is the company's own Toyota Technical High School. It provides a three year course for 8,000 boys in 15-18 age-group. Entry is by examination and while there is no obligation to sign up with Toyota afterwards, the vast majority do. Unlike so many high school children these days elsewhere, the 800 at Toyota have a job lined up for them-a job in a still expanding company that has earned itself a prominent place in the annals of industrial history.

9.5.1 Long-Range Human Resources Development

The bedrock of Japanese management philosophy is the lifetime-one-company-career of employees, which provides for long range human resources planning, career path and development across

functions, slow but steady individual professional growth, strong effort on training, development and education, and long-term company-employee relationship.

Since the Japanese society and culture expects a company to hire an employee for life, there is a tremendous company investment and commitment in educating the employee about company philosophy and culture, train in the necessary skills, habits and, more important, attitudes, and develop him through a variety of on-the-job experiences, and off-the-job training, development and visits and utilize him where the company needs him and where he fits in well with the organisation. Most of the investment in human resources development is company specific. Besides changing horses in midstream, so common in the other industrialized countries, is just not the thing to do and in the closed system of recruitment in Japanese industry, the thought of changing companies in mid career is hardly thought of by most Japanese individuals. There is also a great deal of mutual trust, confidence and dependence established over a long period of time.

9.5.2 Total Employee involvement

Another outstanding feature of Japanese management is the total involvement of employees in problem solving and helping the company to reach the right decision at the right time. Among other reasons, Japan has emerged as the world's largest and most efficient producer of steel is because 2,16,000 workers in the steel industry submitted 2.3 million voluntary suggestions to improve productivity and quality control in 1981. Speaking at the recent international conference on productivity and quality control in Tokyo, Kokichin Takahashi, an executive of Japan Iron & Steel Federation revealed that on an average each worker in the steel industry submitted 10.6 suggestions to cut cost and improve productivity in 1981. Just over 1.8 million or 85 per cent of the suggestions were adopted. This is just one of the reasons why productivity of steel per worker has increased five times during the past 20 years. He went on to illustrate how highly Japanese employees are motivated in their jobs. "We have 30,566 quality control circles in the steel industry. Each group meets in their own time to set up goals which will improve productivity and cut costs. For example, 56,000 employees in Nissan Motor corporation submitted 1.2 million suggestions to improve productivity and quality control in the company in 1981." This was most astounding to the Western delegates.

"One of the most intriguing lessons of the art of Japanese management-one that is close to the spirit of Theory Z-is the Quality Control circle or QC circle. In fact, many American managers who have visited Japan have been struck by the effectiveness of the circle and are determined to implement similar techniques in their own companies at home.

"The explanation for the circle's popularity lies in their unique function. What they do is share with management the responsibility for locating and solving problems of co-ordination and productivity.

The circles, in other words, notice all the little things that go wrong in an organisation and then put up the flag. For the reason the QC circles are useful.

Theory Z says that suggestions from employees in related matters improve their commitment and performance. Involvement of employees gives meaningful participation of employees in the decision-making process, particularly in matters directly affecting them. Such participation of employees generates a sense of responsibility and increases enthusiasm in the implementation of decisions.

The proposal is discussed at every level and the initiator provides details to the supervisors. Problem is thoroughly discussed. Once the decision is taken implementation takes less efforts because the decision has the concurrence of concerned persons. In American this practise is totally reverse. Decisions are taken by the top management and communicated to the cover levels.

9.6 COMPANY COMPENSATION AND BENEFITS

Another fundamental feature of the art and science of Japanese management is the system of employee compensation and benefits, which are related to economic health and welfare of the company. There is a highly visible casual relationship between company health and welfare and employee health and welfare, unlike in the West and many other countries, where the chairman and his top executives may give themselves fat bonuses and salary increases, even while the company is losing money and cost cutting through employees layoffs is operating. Almost every major firm in Japan pays all of its employees a large share of their compensation in the form of a bonus, typically paid twice a year, once in six months.

The bonus each year adds up to five to six months salary of each employee, but the amount is not contingent on individual performance but only on the performance of the company. This compensation system in part shifts the entrepreneurial risk of business from stockholders to employees, who suffer through bad years and prosper in good years, unlike in United states and others, where employees may enjoy salary increases although their company suffers a decline in earnings. Bonuses give employees an incentive to feel part of the firm and motivate them to cooperate in any way they can the lifetime employment system allows the firm to pay a small bonus in a bad year or even defer the payment of the entire bonus to a later year. Thus, a firm can cut its payroll by perhaps 30 per cent without laying anyone off.

When good times return, an experienced and loyal workforce is ready to go. In a good year the employees receive a larger than expected bonus in a lumpsum and tend to save a large fraction of it. This effect, combined with tax incentive to save, has given Japan a rate of saving and a capital formation roughly four times that of

United States. Thus Japanese business can expand rapidly during prosperous times.

Secondly, every major firm in Japan employs a large category of temporary employees, mostly women. Even today, it is rare that a major Japanese firm will hire women into professional and managerial jobs. Women typically start work in production and clerical jobs right out of high school for five or six years. Then they get married, quit work, raise a family. When children enter school, the women often return to their original employer. Although they may work for the next 20 years, they are considered temporary employees and are immediately laid off in slack periods. On the other hand, Japanese firms have shown a great flexibility in scheduling work hours to accommodate women, who may have children to care for. At Sony plants, regular production shifts begin at 8 a.m. but other shifts work from 10 a.m. to 6 p.m. and from 10 a.m. to 3 p.m. in order to accommodate women with responsibilities. The central fact remains, however, that women serve as a "buffer" to protect the job stability of men.

9.7 NEED-HIERARCHY THEORY OF MOTIVATION

Abraham Maslow, an eminent US psychologist, offered a general theory of motivation, called the 'Need hierarchy theory' in his classic paper published in 1943. The salient features of his theory in his classic paper published in 1943. The salient features of his theory are as follows :

- (i) People have a wide range of needs which motivate them to strive for fulfillment.
- (ii) Human needs can be definitely categorized into five types : physical needs, safety, or security needs, social needs, affiliation or social needs, esteem needs and self-actualisation needs.
- (iii) The above needs have a particular structure; they can be arranged into a hierarchy. Physical needs are at the base of the hierarchy while self-actualisation needs are at the apex; safety needs, affiliation needs and esteem needs are positioned in between (see diagram). Needs decrease in their basic nature or essentially as one proceeds from base towards the apex.
- (iv) Humans strive to gratify their needs in a sequential manner starting from the base of the hierarchy and reaching the apex step-by-step. This means that all the needs are not felt at the same time, nor is human effort diffused.
- (v) It is natural for humans, as living beings begin, to seek to gratify their physical needs first. They are more basic than all the other needs. Once people are able to reasonably satisfy

them by making adequate sustained arrangement for their continued satisfaction, they feel the urge to satisfy the next level, safety or security needs and direct their efforts accordingly. In this way, they tend to ultimately reach the top level self-actualisation needs, by sequentially gratifying their lower level needs to the extent possible.

- (vi) Relative satisfaction of a lower level need is a precondition for the activation of the next higher level need. The notion of hierarchy implies that lower level needs get more priority for relative fulfillment than higher level needs. Satisfaction is never absolute; it is relative.
- (vii) A satisfied need does not motivate human behaviour. It only triggers or activates the urge for the next higher level of needs.

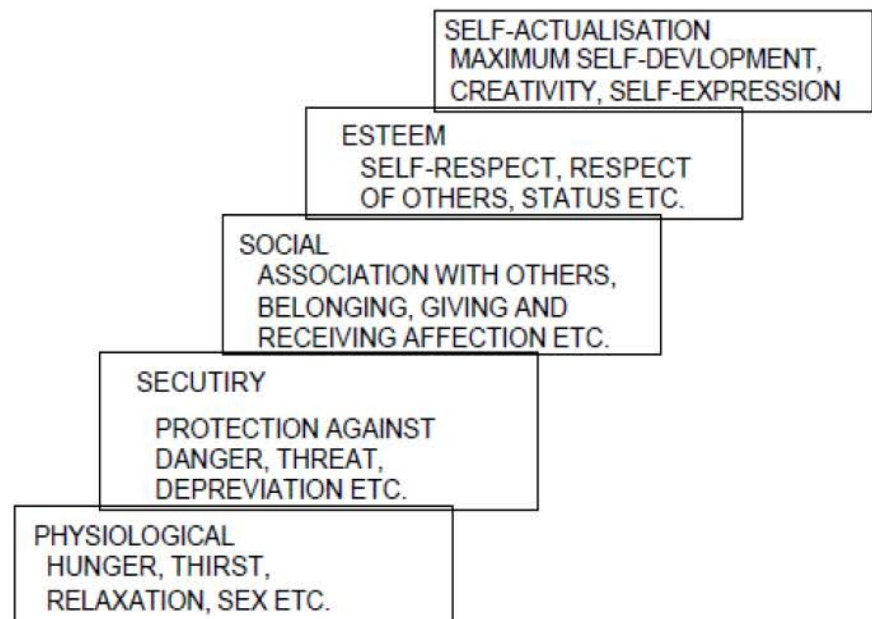

According to Maslow, the urge to fulfil needs is a prime factor in motivation of people at work. Maslow recognised that human needs are multiple, complex and inter-related. He also emphasized the systematic and sequential processes of need development and need fulfillment among individuals.

Maslow's model attained extensive popularity and research attention. Its popularity stems from its basic simplicity and intuitive appeal. The propositions made by Maslow could not be rigorously tested empirically. Hence his theory could not be validated. However, Maslow's theory is said to contain some fundamental human truths which do not require any proof.

Even so, the need hierarchy theory is widely criticised for its over-simplification of human needs and motivation. It is pointed out that need recognition and fulfillment do not follow any specific sequence or hierarchy. All the needs are present in more or less degree among some people whether they are capable of being fulfilled or not. In others only one or two types of basic needs are felt. As a need is

satisfied it becomes more important and not less. Human beings are motivated not by the interaction among needs and between needs and incentives. Also, apart from needs, there are other motivating factors also, such as perceptions, expectations, experiences and so on.

9.8 MOTIVATIONAL TECHNIQUES

Certain important motivational techniques may be summarised as below :

9.8.1 Monetary incentives

Incentives like cash emoluments, fringe benefits, security of tenure, conditions of service, etc. are some of the monetary techniques which may be adopted by the management to motivate the staff in an industrial organisation.

9.8.2 Job-based techniques

To satisfy the social and psychological requirements of the job holder, certain job-based techniques like job simplification, job rotation, job enlargement and job enrichment may be followed. Job rotation reduces the boredom and enlarges one's knowledge. Job enlargement involves de-specialisation and an increase in the number and type of operations assigned to an individual to make the job more pleasant and interesting. Job enrichment encourages an employee to plan his own work and control the pace and quality of his output.

9.8.3 MBO technique

According to it both men and boss participate and jointly determine each individual's major areas of responsibility in terms of results expected of him and use these measures as guides for operating the unit and assessing the contribution of each of its members.

9.8.4 Leadership techniques

Autocratic, democratic and participative supportive styles of leadership have their own implications for employee motivation, morale and productivity in the short term and in the long run.

9.8.5 Sensitivity training technique

It is training technique given to groups of managers themselves so that they may behave with and motivate their subordinates better. This sort of training is imported to make the managers :

- i. understand themselves better,
- ii. Become more open-minded about the needs and motives of their subordinates,
- iii. develop insight into group process and work situations.
- iv. cultivate a systematic and scientific thinking process
- v. develop a systems view of the total organisational environment and
- vi. acquire behavioural skills in dealing with subordinates.

9.9 FINANCIAL AND NON-FINANCIAL INCENTIVES

The term 'incentive' has been used both in the restricted sense of participation and in the widest sense of financial motivation. Incentives are the inducements which are offered to employees in order to direct their behaviour towards enterprise objectives. It refers to all the plans that provide extra pay for extra performance in additions to the regular pay. Incentives are extra financial motivation. They are designed in order to stimulate human effort by rewarding the person, above the time-rated remuneration, for improvements in the present results. Incentives are the motivational techniques. There are divided into (i) financial, and (ii) non-financial incentives.

9.9.1 *Financial Incentives*

Financial incentives have an important contribution to make within the total motivation pattern. These are payments directly or indirectly in money. Financial motivators provide extra-motivation, by rewarding the worker over and above his regular pay for performing more than the targeted work. Financial motivators are in the form of more wages, salaries, business, profit sharing, leave with pay, bonus, retirement pay, vacation pay etc. Sometimes monetary and financial incentives are considered as most important motivators. This is because money is an essential instrument for satisfying primary basic needs of human beings i.e., food, clothing and shelter. Money has got symbolic appeal and has exchange value can be exchanged for other useful things.

Money is the most important motivator to people who are young for those who want to raise their families. Trade unions all over the world carry their struggle on the basis of monetary reward. If the organisation want to attract good persons then it has to offer better wages.

9.9.2 *Financial incentives are of two types*

(a) individual incentives, (b) group incentives, (c) organisation incentives. In individual incentive rewards of incentives are solely based on individual performance. Individual incentives refer to all such plans which induce an individual to achieve high performance so as to earn higher financial rewards. It is an extra payment made to an individual over a specified amount for his production effort. Such a system is feasible where an individual can increase the quantity and quality of his output by his personal efforts. Generally the payment is on a monthly basis.

Group incentive provide the payment of a bonus either equally or proportionately to individuals within a group or area. Group incentives are appropriate where people have to work together and team work is encouraged, and where high levels of production depends a great deal on the co-operation of the team of workers. This bonus is related to the output achieved over an agreed standard or the time saved on job. These incentives are generally applied to small teams and are larger than the individual wage

incentives. These are calculated on the basis of the output of the team and are divided among the members or proportionally.

Organisation wide incentives involves co-operation and collective effort of the employees and management to accomplish the objectives.

Such schemes improve communication, increase sense of participation. It is simple and cost of administration is low.

Generally it is seen that people engaged in same types of work are given equal wages. Under such circumstances money tends to be diluted as a motivator. Concluding money can motivate people if their wages are related to their performance.

9.9.3 Non-Financial Incentives

These motivators are in the nature of better status, recognition, participation, job security, greater authority, higher responsibility, improved working conditions, greater leisure, team-spirit, challenging job, competition etc. All these motivate workers to raise their productivity. Non-financial incentives provide psychological and emotional satisfaction to the workers. These incentives are very important for the satisfaction of social and psychological needs which cannot be provided by money alone. These satisfies the egoistic needs like status symbol is created in the organisations by providing various facilities. To get these facilities a person will show certain amount of performance. Status acts as a motivator because when one achieves certain facilities then he tries to get better status by working more. competition is also a good motivator. This is because of the fact that in order to prove himself better than the other one, person puts in all his efforts, in turn it is beneficial for the whole organisation.

Recognition has been proved as an excellent motivator because each and every one wants recognition. Recognition may be in the form of words of praise or a pat on the back or a letter of appreciation etc. If the performance of people is not recognized and everyone is treated on the same footing then good people will not put in their best efforts, because when the person knows that his performance is known to his boss then he will try to improve it more.

When the job is made more important and challenging workers gets the opportunity for the fulfilling employee's psychological hunger and help him is growing psychologically. It gives him job satisfaction and raises his morale. Even when the workers are asked for the participation in decision making process, it satisfies his ego. They feel important and give their best possible support by giving proper solutions.

Therefore, these non-financial incentives are great motivators and helps in fulfilling psychological needs of the employees. Generally the non-financial incentives are in non-monetary terms.

CHECK YOUR PROGRESS

2. Write the types of financial incentives

.....
.....
.....
.....
.....

SUMMARY

The term motivation is derived from the Latin word 'movere' (to move). Motivation is defined as the intrinsic state that energizes, directs and activates the behaviour of the individual towards attainment of goals. Motivation is productivity factor in industry. It is the sum total managerial science. The most important task of the management is to get the work done by the subordinates and achieve results. Getting the work done depends mainly on whether a person has been motivated to do it. The five elements of Motivation are :

(1) Concern or socialisation; (2) Co-ordination; (3) Long-range human resource development; (4) Total employee group involvement in problem solving; (5) attractive company compensation and benefits.

Certain important motivational techniques may be summarised as below :

Monetary incentives, Job-based techniques, MBO technique, Leadership techniques, Sensitivity training technique, financial and non-financial incentives

QUESTIONS

1. What is motivation?
2. What do you understand by motivation? Explain the meaning.
3. How many types of motivations are there.
4. Explain the Mc Gregor's theoris with their comparision.
or
Comapre the theory X and theory Y prepounded by Mc gregor.
5. Explain the herebesg's motivation-hygiene theory.
6. Explain theory Z.
7. What are the various motivational techniques.

10. LEADERSHIP

- 10.1 WHAT IS LEADERSHIP?**
- 10.2 CHARACTERISTICS OF LEADERSHIP**
- 10.3 DEFINITIONS OF LEADERSHIP**
- 10.4 GREAT MAN THEORY OF LEADERSHIP**
- 10.5 LEADERSHIP PATTERNS**
- 10.6 ROLE OF LEADERSHIP**
- 10.7 LEADERSHIP STYLES**
- 10.8 TECHNIQUES OF LEADERSHIP**
- 10.9 FUNCTIONS OF LEADER**
- 10.10 QUALITIES OF LEADERSHIP**
- 10.11 HINDERANCES TO LEADERSHIP**
- 10.12 PROCESS OF LEADERSHIP**
- 10.13 DEVELOP VOLUNTARY CO-OPERATION**

OBJECTIVE

After this unit you will be able to explain

- Understand characteristics, role, styles, techniques, functions & quality of leadership.
- leadership skills.
- Develop voluntary cooperation.

LEADERSHIP**10.1 WHAT IS LEADERSHIP**

Peter F. Drucker, an original thinker on management science, considers 'leadership' as a human characteristic which lifts a man's vision to higher sights, raises a man's performance to higher standards and builds man's made by able leaders like Napoleon Bonaparte, George Washington, Winston Churchill, Mahatma Gandhi, John F. Kennedy and so on. As a matter of fact every group, may it be small or big requires a strong leader to guide, inspire and direct its members towards the attainment of a particular objective. George R. Terry has rightly remarked that "The will to do is triggered by leadership, and lukewarm desires for achievement are transformed into burning passion for successful accomplishments by the skilful use of leadership."

One of the descriptions of leadership is that it is an influence-interaction process between the leader and his group of followers/subordinates. Leadership is an interpersonal and a social process. A person's leadership position exists only in relation to people and not things. A leader is one who happens to hold a sway over some of the attitudes, actions and behaviour of a set of people, who comprise his constituency. The latter willingly allow themselves to be influenced by the former. Influence and interaction of ten are part of the same process; one facilitates the other. In a group consisting of the leader and his followers, the frequency and intensity of the leader's interaction with his followers tend to be high.

Social psychologists Katz and Kahn defined leadership to mean an ability of a person to arouse a group's compliance and co-operation to this initiative beyond the normal call of duty. Leadership is a power relationship. The person who is in the position of leadership hold power over his followers. Power refers to an ability to influence. The leader is at the centre of the group's power structure. The leader has access of one or more of the following sources of power (i) Knowledge, information and experience, (ii) Resources for rewards and punishment, (iii) Formal authority, (iv) Charisma, (v) Distinct personal qualities or traits.

The process of influence and interaction may be partly rational in the sense that it is goal-directed, whether it is towards group performance or group satisfaction or a combination of the two. Other related goals are : group cohesiveness, development,

discipline, motivation, morale, team work and so on. Some of them are higher goals while others are sub-goals.

Several approaches or styles are available to leaders to initiate and activate the influence-interaction process. Some of the more prominent among them are : directive leadership. The elements of these styles differ from each other, though some of them are overlapping. By adopting one or more of these styles, the leader may be able to influence the perceptions, attitudes, needs, goals, rules, values, behaviour and performance of his followers in directions which he considers desirable. However, the effectiveness of any influence interaction style depends not only on the leader's abilities and initiatives but also on the characteristics of his group members, the composition of the group, the task environment and several other related factors.

Influence is some times reciprocal between the leader and his group members. The latter, by their own ability to interact with the leader, can influence the attitudes and behaviour of the former. The entire group consisting of the leader and his followers may be characterized by a network of influence-interaction relationships. Even so, the net influence exerted by the leader is invariably more than other individual members. Otherwise, he ceases to be the leader.

The type of influence-interaction process which is generally associated with the behavioural approach is popularly credited with positive and progressive results. In this approach, the leaders's attempts at influence and interaction in relation to his followers may be described as under :

1. He works closely with his group members, is easily accessible to them and establishes warm, friendly relations.
2. He helps members to set clear goals and enhance their capability for self-reliance, self-direction and self-control.
3. He respects their self-esteem and personality and responds confidence in them.
4. He expects the group to be loyal to the goals, tasks and performance requirements of the work unit-and not to him personally.
5. He shares his knowledge, expertise and information with his subordinates.
6. He promotes two-way communication with his group, he is quick and accurate in his communication attempts.
7. He encourages people to recognise their strengths and weaknesses, to develop themselves and to utilize their skills effectively.
8. He enlists his group members co-operation, invites their views and suggestions, involves them in decision-making and allows due weightage to their contributions.
9. He recognizes good performance and behaviour and attempts to reward it in an appropriate manner.

10. He shows personal interest in the needs, aspirations and values of his group members and helps clear the paths for their achievement.

The concept of 'Leadership' has not been exactly defined by anybody. Some people believe that "Leaders are born and not made;" while others say, "Leadership qualities can be acquired." Truly speaking, "Leaders are both born and made." Those who possess the essentials of leadership can undoubtedly develop the ability to utilize it to better advantage through experiences which give them the opportunity to lead others.

10.2. CHARACTERISTICS OF LEADERSHIP

Some important characteristics of leadership are as follows :

10.2.1 A leader must have followers

Because without followers, leadership cannot be imagined. It does not exist in vacuum. The necessary implication of this ingredient is that a leader must receive habitual obedience from his team of followers. In other words, there must be acceptance of his leadership.

10.2.2 There must be working relationship between the leader and his followers.

It means that the leader himself must be an active participant; else, he will have no effect.

10.2.3 The leader, by his personal conduct, must set an ideal before his followers

His behaviour must stimulate others for hard and honest work. As remarked by L.G. Urwick, "It does not what a leader says still less what he writes, that influences subordinates. It is what he is. And they judge what he is by what he does and how he behaves."

10.2.4 There must be community of interests between the leader and his team of workers

If the objectives of the two are different and both move in different directions, it is no leadership. Really speaking, leadership is the activity of influencing people to strive willingly for mutual objectives. It is the leaders who tries to reconcile differences and bring about a workable compromise between the goals of the organisation he represents and the individual as well as group aspirations of the men he leads.

It should be noted in this connection that industrial leadership is different from 'pre-eminence'. A leading doctor or a lawyer is not a leader of men but one who excels in his respective field. The verb 'to lead' has two meanings, "to excel, to be in advance, to stand out" and "to guide, govern and command others, to head an organisation." The leadership concept under discussion is that associated with the second meaning. Further, the old concept of leadership too is different from its present meaning. According to the old conception, the leaders influenced those he led by his forceful and compelling personality. He used to dominate over

others through autocratic techniques. But, according to the present conception, the leader attempts to draw out the best in his followers by training them to share the leadership with him. This he does by integrating the experience of all and using it to accomplish the major activities which are acceptable to all.

10.3 DEFINITIONS OF LEADERSHIP

Leadership is a great quality and it can create and convert anything, Terry points out : "a leader shows the way by his own example. He is not a pusher, he pulls rather than pushes." Certain beautiful definitions of leadership may be enumerated as below :

10.3.1 Alford and Beatty

"Leadership is the ability to secure desirable actions from a group of followers voluntarily, without the use of coercion."

10.3.2 Chester I. Barnard

"It (Leadership) refers to the quality of the behaviour of the individual whereby the guide people on their activities in organised efforts.

10.3.3 Encyclopaedia of the social Sciences

"Leadership is the relation between an individual and a group around some common interest and behaving in a manner directed or determined by him.

10.3.4 R.T. Livingston

He describes it as : "The ability to awaken in others the desire to follow a common objective."

10.3.5 Peter Drucker

He defines leadership as : "It is not making friends and influencing people, i.e., salesmanship, Leadership is the lifting of man's visions to higher sights, the raising of man's performance to higher standards, the building of man's personality beyond its normal limitations."

10.3.6 Koontz and 'O' Donnell

He defines managerial leadership as : "The ability to exert interpersonal influence by means of communication, towards the achievement of a goal. Since managers get things done through people, their success depends, to a considerable extent, upon their ability to provide leadership."

10.3.7 "Leadership is the link between the plans and action

It consists of communicating plans to workers, watching results, appraising responses, motivating individuals-in short, moving the organisation towards achievement of the objectives."

10.4 GREAT MAN THEORY OF LEADERSHIP

Several theories of leadership purported to explain who leaders are, how they emerge, what they do, how they behave and achieve effectiveness have been advanced by theorists. One of the early

theories in the field was the great man theory popularized from the time of ancient Greeks. The theory asserts that leaders are born and not made. This is especially so with great leaders. Examples are drawn from famed figures like Nelson, Napoleon, Gandhi, Adi Shankara Charya, De Gualle and so on. They had certain genetic and inborn leadership qualities and personalities. The theory does not accept the notion that leadership qualities can be acquired and people can be trained to assume leadership. It regards that great leaders are different from the common mass of followers and even ordinary leaders. Great leaders are 'Gifts of God' to mankind. They bestow great good on people by their decisions and activities which are also divinely destined and approved.

The great man theory seeks to rationalize the greatness of leaders. The theory also identifies certain qualities of great leaders like intelligence, imagination, initiative, decisiveness, achievement orientation, personal charisma, pragmatism, and so on. It is contended that such qualities are simply not amenable for possession other than by birth and God's will.

The great man theory is now regarded as almost obsolete and absurd. The theory lost credibility in general because it had little scientific and empirical basis. It does not explain who are leaders, how they emerge, how they behave and achieve effectiveness.

CHECK YOUR PROGRESS

10. Write the characteristic of leadership

.....

10.5 LEADERSHIP PATTERNS

1. The manager makes decision and announces. It is an extreme form of autocratic leadership, whereby decisions are made by the boss who identifies the problem, considers alternative solutions, selects one of them and then reports his decision to his subordinates for implementation. He does not perceive the viewpoint of others nor does he provide any opportunity to the subordinates directly in the process of decision-making.
2. The manager sells his decisions. It is a slightly improved form of leadership wherein the manager takes the additional step of persuading the subordinates to accept his decision. Although he realizes that his decision is likely to be resisted by the employees, but he tries to reduce this resistance by attempting to sell his decision and by bringing out the gains from his decision to the employees.
3. The Manager presents his ideas and invites questions. There is greater involvement of the employees in this pattern. The boss arrives at the decision, but provides a full opportunity to

his subordinates to get fuller explanation of his thinking and intentions. In other words, he presents his ideas and encourages questions from the subordinates.

4. The Manager presents a tentative decision subject to change. Herein the decision is tentatively taken by the manager but he is amenable to change and influence from the employees. This type of leader may say : "I would like to hear what you have to say about this plan that I have chanded out. I will appreciate your frank reaction but will reserve for myself the final decision."
5. The Manager may present the problem, get the suggestions and then take his own decision. Herein sufficient opportunity is given to the employees to make suggestions that are coolly considered by the manager.
6. The Manager may define the limits and request the group to make a decision. A manager of this style and pattern lets the group have the right to make the decision. Under this style of management, the subordinates are able to take the decision to the limits defined by the manager.
7. The manager may permit full involvement of the subordinates in the decision-making process. It is often designated as 'Democratic leadership.'

10.6 ROLE OF LEADERSHIP

Leadership is a dynamic process. Its important functions are : (i) to guide and motivate the behaviour of the subordinates in furthernace of the objectives of the organisation, and (ii) to understand the feelings of the subordinates and their problems as the plans are translated into action.

10.7 LEADERSHIP STYLES

There are various types of leaders in industry today. Messra, Alford and Beatty have classified them into the following categories :

10.7.1 Intellectual leaders

As the term implies, intellectual leaders are those who win the confidence of their followers by their superior intellect or knowledge. Nearly in all big business concerns there are experts whose advice is sought on matters in which they are the intellectual authority. He may be a purchase specialist, a production expert, a job analyst or an advertising specialist. Regardless of his function, he is able to get results through others because they desire to use his superior knowledge.

10.7.2 Institutional leaders

An institutional leader is one hwo holds his position because of force of prestige attached to his office. The position he holds enables him to influence his followers, sometimes because of the habits of obedience that certain followers have, sometimes, because of the habits of obedience that certain followers have, sometimes, because of a respect for the position and beyond that for the enterprise as a

whole, and sometimes because of the dependence of the subordinate upon his superior.

10.7.3 Democratic leaders

As the name implies, a democratic leader is one who always acts according to the wishes of his followers. He does what the gang wants. He follows the majority opinion as expressed by his group, and is their representative to management. He holds his leadership position because he is loyal to his group, is always concerned with their interests, is friendly and helpful to them, and is always concerned with their interests, is friendly and helpful to them, and is always ready to defend them, individually and collectively.

10.7.4 Autocratic leaders

An autocratic leader is one who dominates and drives his gang through coercion, command and the instilling of fear in his followers. Such leaders love power and love to use it in promoting their own ends. They never like to delegate their power for they fear that they may lose their authority in this way.

10.7.5 Persuasive leaders

The persuasive leader possesses a magnetic personality that enables him to influence his followers to join with him in getting things done. He is the type who can say, "Let's go, boys" and the whole gang responds because they love and respect him, have confidence in him, and want his goodwill.

10.7.6 Creative leaders

The creative leader uses the techniques of 'circular response' so ably described by Follett to encourage ideas of flow from the group to him as well as from him to the group. He draws out the best in his followers without exerting an undue personal influence on the people. The creative leader controls through united, voluntary, enthusiastic activities by the members of his group directed by him towards specific goals which are satisfactory and worthwhile to all.

10.8 TECHNIQUES OF LEADERSHIP

For the convenience of study, the technique of leadership may be studied under the following heads :

10.8.1 Securing co-operation

Nothing is so important to the success of an industrial enterprise as the ability of the leaders to secure from all who are associated with the undertaking, the willingness and desire to give their best efforts in furthering the objectives and ideas for which the concern has been established. To secure this 'will to collaborate', there must be a willingness, on the part of both parties, to work with each other. There are certain essentials for securing co-operation and they are as below : (i) the leader must convince each subordinate that the successful operation and continued life of the enterprise are also of vital interest to him. (ii) The leader must set a good example by co-operating with his superiors and with others at his own level. (iii) He

should be a psychologist and should try to do everything possible to determine what his followers want most. The best leader does not ask people to serve him, but the common end. He does not have followers, but co-workers.

10.8.2 The use of power

With leadership goes power. Wise leadership uses power in the best interest of the enterprise and the groups related to it. As regards the use of power, the following remarks of Tead are worth noting; "Power comes by virtue of what we deeply are and do, and every great leader is a silent but eloquent witness to the fact that his power derives from his devotion, his loyalty and his helpfulness to his followers in a common and important cause." There are certain persons who seize power rather than earn it. It is not advisable. In the words of Jesus Christ "And whosoever will be chief among you, let him be your servant."

10.8.3 Co-ordination and command

In order to get the desired action, a successful leader must co-ordinate the acts of his co-workers through orders or commands. These orders should be definite, sequential, flexible and open. The term 'definite order' means that the command may come not as an oral order from a superior but as part of the system of communication which has been established for the accomplishment of the planned goals. The 'sequential order' arranges the acts to be performed in a sequence and specifies when each shall be done. The 'flexible order' is one in which the individual ordered may select the method, and time for carrying out the definite task which has been assigned using the pre-determined means for doing so. The 'open order' is one in which the leader specifies the goal and leaves the details to the subordinate.

Commands to be obeyed must be received and understood. If the proper results are to be obtained, the recipient must know what is expected of him, where he is to do it, how it is to be done, when it is to be completed, and why? Barnard has made it clear that orders to be enforceable must be possible and acceptable to the person. To quote Barnard, " There is no principle of executive conduct better established in good organisations than that orders will not be issued that cannot or will not be obeyed." Authority, discipline and morale are destroyed by violating this principle. A leader should understand the proper use of authority if he is to secure obedience from his followers.

10.8.4. Maintaining discipline

Discipline is the force that prompts in individual or group to observe rules, regulations and procedures that are deemed necessary to the attainment of an objective; it is the force or fear of a force that restrains individuals or groups from doing things that are deemed destructive of group objectives. It is also the exercise of restraints or enforcement of penalties for the violation of group regulations. Consistency on the part of leader is essential if he is to be successful in using the technique of discipline. When the

subordinate is right, he must be backed and when he is wrong he must be punished.

10.8.5. Developing high group morale

Morale is the state of mind or attitude of individuals and groups growing out of the conditions under which they operate, including their operating environment, their particular activity or work, their association in the group, the quality of their leadership and the demands the workers is making upon his job. Lighten has defined morale "as the capacity of a group to full together persistently and consistently for a common goals." According to him, the five factors of morale are : (i) Confidence of the individual members of a group in the purpose of the group; (ii) Confidence of the different members of the group in the leadership at all levels, the ability of the leadership and the concern of the leadership for them; (iii) Confidence that members of the group have in the other members of the group the feeling that they know what they are doing, that they will be loyal to the group, that the others will be there when the balls is based to them; (iv) Organisational efficiency; (v) The mental and emotional and physical health of the individuals and recreation. Very often this is considered the whole of morale. When somebody sets out to improve conditions, he may attack only this fact. To develop high group morale the leader must govern his own actions by the effect they will have on these five factors.

10.9 FUNCTIONS OF A LEADER

There are five important functions of a business leader and they may be briefly summarized as follows :

10.9.1 To take the initiative

It is the first and the foremost job of an industrial leader to take the lead in all activities. He should not expect others to guide or direct him. He himself should come in the field, lay down the aims and objectives, commence their implementation and see that the goals are achieved according to the pre-determined targets.

10.9.2. To represent the undertaking

A leader is true representative of the entire organisation. He represents the undertaking and its purpose both to those working for it as well as to the outside world.

10.9.3. To act as the frind, philosopher and guide of the undertaking :

It is the primary function of the leader to guide and direct the organisation. He should issue the necessary instructions and see that they are properly communicated. It is an old saying that "No high quality avails where the rule of order fails."

10.9.4. To interpret

It is a delicate task of the business leader to assign reason to his every command. If his instructions are irrational and there is no backing by reasons or logic, they are bound to be ineffective. He has

to instruct things in such a way that they are intelligible to all concerned and their cooperation is readily forthcoming.

10.9.5. To encourage team work

Last but not the least, the leader must act like the captain of a team. He must try to win the confidence of most of his colleagues, if not all. Without team work he cannot be successful and the leadership may fail.

10.10. QUALITIES OF LEADERSHIP

As regards the essential qualities of a leader, the following tabular statement containing the views of some distinguished thinkers, is quite illuminating :

THINKERS	QUALITY
SLIM	1. Courage
	2. Will-power
	3. Judgement
	4. Flexibility
	5. Knowledge
	6. Integrity
TEAD	1. Physical and Nervous Energy
	2. Enthusiasm
	3. Sense of Purpose and Direction
	4. Technical Skill
	5. Integrity
	6. Friendliness and Affection
	7. Decisiveness
	8. Intelligence
	9. Faith
FOYOL	1. Health and Physical Fitness
	2. Intelligence and Mental Vigour
	3. Moral Qualities
	4. Knowledge
	5. Managerial Ability
BARNARD	1. Vitality and Endurance
	2. Decisiveness
	3. Persuasiveness
	4. Stability of behaviour
	5. Intellectual Capacity
	6. Knowledge
HILL	1. Courage
	2. Self-confidence
	3. Moral Qualities
	4. Self-sacrifice
	5. Paternalism

6. Fairness
7. Initiative
8. Decisiveness
9. Dignity
10. Knowledge of Men

We need not be befogged at the absence of agreement among these thinkers on the essential requisites of a leader. F.M. Viscount Slim has chosen six basic essentials primarily for military leadership even though these can apply with equal force to leadership in other walks of life. Fayol and Barnard, on the other hand, speak essentially of leadership in industrial and business world. Tead and Hill are more elaborate in their assessment of leadership qualities. On a careful consideration of the meaning attached to these qualities by different thinkers one could broadly classify these essentials into distinct categories. In a broad way the qualities which are necessary for an industrial leader may be summarized as follows :

10.10.1 An instinct to take lead and initiative

The most important quality of an industrial leader is an instinct to take lead and initiative. Business is not a bed of roses. It is full of uncertainties, formalities and complexities; decisions are to be taken in business every now and then. Hence, the leader must possess certain creative abilities, quality of imagination, invention and innovation and courage to face realities of life boldly and cheerfully. He must, like a pioneer, initiate many good activities, instead of waiting to be wire-pulled by others. The simplest meaning of initiative is "to do the right thing without being told."

10.10.2 Quick grasp and power of judgement

More often than not, a leader has to listen to his subordinates. He must possess the quality of attending to all irrespective of caste, colour or status. His grasp of the situation should be quick and the decision should also be communicated at the earliest. This needs maturity of mind, penetrative thinking and a scientific way to approach. Further, whatever decisions is taken he should stick to it; 'Implement or not to implement' attitude is not desirable. The power of judgement and ability to decide comes from self-confidence and self-control. Decisiveness is an essential since qua non for getting the right action at the right time. Failure to reach a decision is destructive to morale and sometimes is more damaging to the efficiency of the enterprise than making a wrong decision.

10.10.3 Sense of responsibility

A leader must be a true worker and not a shirker. He must be in a position to bear the burden of all his decisions upon himself. Authority and responsibility generally go together. As an industrial leader possesses certain authority. Barnyard has defined responsibility as an "emotional condition that give an individual a sense of acute dissatisfaction because of failure to do what he feels he is normally bound to do or because of doing what he thinks he is

morally bound not to do in particular concrete situations." Because the leader will avoid such dissatisfactions, his behaviour is stable and can be predicted by his followers. This is an important element in industrial leadership.

10.10.4 Moral qualities

Among the moral qualities, courage-not in physical sense along, but moral courage-is essential. As F.M. Slim says, Without courage three are no virtues, for faith, hope, charity and all the rest do not become virtue until it takes courage to exercise them. Moral courage enables a person to stick to without faltering, a determined course of action which his judgement has indicated as the best suited to secure the desired results. Assailed by doubts, misgiving or even external pressure a leader should not change his decision unless it is clearly manifested that his earlier decision was radically wrong. It is again the dictates of moral courage that one should take the responsibility of his action and not pass on the blame, should the action be blame-worthy, to one's subordinates.

In fact, one could hardly over emphasise the importance of moral qualities in the make-up of a leader. A pure luminous heart seeking other hearts in love and esteem can do miracles. In industry one can find the best exponent of this attitude in Charles Schwab, one of the highest paid executives in the United States Steel Industry. Schwab's great secret of success was this :

"Charles Schwab was passing through one of his steel mills one day at noon when he came across some of his employees smoking. Immediately above their heads was a sign which said, 'No smoking.' Did Schwab point to the sign and say; 'Can't you read?' Oh, not, not Schwab. He walked over to the men, handed each one a cigar, and said, 'I'll appreciate it, boys if you will smoke these on the outside.' They knew that he knew that they had broken a rule-and they admired him because he said nothing about it and gave them a little present and made them feel important. Couldn't keep from loving a man like that, could you?"

And what can the results of such attitude be, one can find from his : One mill was not giving its quota of production. The mill manager reported that his threat or curse was of no use. Workers would not give more production. It happened to be the end of the day just before the night shift came in. With a piece of chalk in hand Schwab turned to the nearest man : "How many heats did your shift make today?" "Six." Without another word, he chalked a big figure of six on the floor, and walked away. When the night shift came in they saw the figure '6' and asked what it meant. "The big boss was in here today," the day men said. The next morning Schwab walked through the mill again. The night shift had rubbed out the '6' and replaced it with a big '7' chalked on the floor. So night shift thought they were better than the day shift? Well, the day shift pitched in with enthusiasm and when they quit that night, they left behind them an enormous, swaggering '10'. Things were starting up. Shortly this mill was turning out more work than any other mill in the plant.

10.10.5 Flexibility

Rigidity of decision is the way of an autocrat. Success warrants that a leader should have an attitude of flexibility. Today when conditions in all spheres, political, social, industrial and scientific, change with bewildering rapidity, flexibility of mind is vital. As Thomas Carlyle said, "A foolish consistency is the hobgoblin of a little mind."

10.10.6 Intellectual capacity and technical competence

It is an essential quality of leadership. Without intellectual capacity no leader can be successful. Besides, he should be the 'Jack' (if not the 'Master') of all the activities of the undertaking. It is only then that he can successfully perform the functions of planning, organising, directing, controlling and execution. He should also possess a working knowledge of the laws of the land, particularly the mercantile and industrial law.

10.10.7 Ability to integrate and inspire

The most important task of the leader is to get the best from others and this is possible only if the leader knows how to integrate. Knowledge of subject and technique is important; but what is more important is the knowledge of men working under the leader. An industrial leader has to deal not only with an army of labour and other personnel in the factory, but he has also to deal with other groups of people such as customers, government officials, shareholders and the laymen; hence he must be well versed in the task of human relations. His task would be highly facilitated if he possesses a clean head and a broad heart. Only such a man can inculcate team spirit and feeling of esprit de corps amongst his colleagues.

An attempt has been made in the above paragraph to paint certain characteristics of industrial leadership. What is, however, of importance, is that a leader has to have these qualities integrated within himself. Just as a Herculean stamina will alone fail to carry a person on to the top, preponderance of moral virtues and absence of mental qualities is likely to make him an ineffectual moralist crying in the wilderness in self-pity and frustration. A leader has to become and remain 'the whole man' so that he is capable of standing alone, fit to be trusted with power, a strong but humble individual who has learnt that the reward for good service is a demand for more service. As Noel Frederick Hall puts it, one of the ingredients in developing this capacity to apply to knowledge and the fruits of experience, that grows with the carrying of responsibility.

10.11 HINDERANCES TO LEADERSHIP

In contrast to the above desirable qualities of leadership, there are certain failings of individuals which affect their ability to lead others. Some of the common hindrances to leadership are as follows : (1) Certain leaders are not close enough to their followers to know or anticipate their reaction when new condition must be met. (2)

Some are emotionally immature, resulting in loss of temper or other form of emotional instability when under pressure. (3) Some lack human understanding and, therefore, build antagonism instead of friendship into their relations with others. (4) Some lack foresight, the ability to look ahead, to anticipate problems and to plan the work of the group. (5) Some are not big enough for their jobs and attempt to compensate for their feelings of inferiority by a superior attitude towards their followers. (6) Some fail to reveal their attitude and intentions to their subordinates or to invite expressions of opinion from them. (7) Some depend too much on punishment and financial reward as motivating forces, and overlook praise, recognition, self-expression and pride in accomplishment. (8) Some fail to be consistent in their behaviour towards others, thus making it impossible for subordinates to know what to expect, and to have the resulting senses of security. (9) Some fail to co-operate with others in working for the common good of all.

A good leader, therefore, analyses his conduct periodically, to be sure that faults of this kind are not becoming habitual. Such self-analysis enables him to correct unsatisfactory conditions before they do permanent damage.

Industrial leaders are developed by improving the natural talents which individuals possess. This is accomplished through formal education, industrial training and self-development. The formal education required for the development of industrial leader should be rich in the humanities and sciences, broadening their interests and understanding. It should be an education which develops mental discipline and an understanding of human relations. Besides formal education, participation in leadership training programmes in industry is also beneficial in developing leadership characteristics.

10.12 PROCESS OF LEADERSHIP

To guide and motivate the employees and understand their feelings, a leader has to undertake four major functions :

(1) Develop voluntary co-operation; (2) Direct and discipline employees; and (3) Listen properly.

10.13 DEVELOP VOLUNTARY CO-OPERATION

A good leader always attempts to develop voluntary co-operation from his subordinates. The spirit of co-operation depends in toto on the feeling which the subordinates have towards their superiors. The following guidelines of executive behaviour would help in developing and nurturing voluntary co-operation :

1. **Trust and friendliness** : It means that the employees must be sure of the genuineness and integrity of the superior.
2. **Support for subordinates** : A subordinate will give co-operation if he is sure that his superior will give support.
3. **Participation** : It is a common experience of all management experts that a more democratic type of leader normally can develop greater voluntary co-operation.

- 4. **Consistency and fairness** : Nothing upsets the subordinates more than an inconsistent behaviour on the part of the superiors.
- 5. **Recognition of individual temperaments of subordinates** : The difference in the temperaments of the subordinates be recognised and the executive behaviour should be modified to suit each individual.
- 6. **Positive approach** : A manager who appreciates the good points more than the depreciation of the bad points generally strikes a more favourable response from the workers.
- 7. **Removal of grievances** : If there are grievances, they must be redressed quite in time.

10.13.2 Direct and Discipline Employees

In the process of leadership, the leader has to give official instructions to his subordinates. These instructions must be clear, complete and intelligible. Moreover, there should be constant follow up of the instructions, which may be modified in the light of the practical difficulties encountered.

10.13.3 Listen Properly

The manager must give a patient hearing to the viewpoint of his subordinates. If he will not listen properly and give his decision quickly, the subordinates may resist it and may come out with their own views. Good listening requires a considerable training of mind and speech. It requires respect for the individuality of the subordinate and the personal discipline on the part of the manager.

<p>CHECK YOUR PROGRESS</p> <p>2 Write the role of leadership</p> <p>.....</p> <p>.....</p> <p>.....</p> <p>.....</p>

'Leadership' as a human characteristic which lifts a man's vision to higher sights, raises a man's performance to higher standards and builds man's made by able leaders like Napoleon Bonaparte, George Washington, Winston Churchill, Mahatma Gandhi, John F. Kennedy and so on. As a matter of fact every group, may it be small or big requires a strong leader to guide, inspire and direct its members towards the attainment of a particular objective. Some important characteristics of leadership are as follows :

A leader must have followers, There must be working relationship between the leader and his followers, The leader, by his personal conduct, must set an ideal before his followers, There must be community of interests between the leader and his team of workers, "Leadership is the ability to secure desirable actions from a group of followers voluntarily, without the use of coercion." It consists of communicating plans to workers, watching results, appraising responses, motivating individuals-in short, moving the organisation towards achievement of the objectives." The great man theory seeks to rationalize the greatness of leaders. The theory also identifies certain qualities of great leaders like intelligence, imagination, initiative, decisiveness, achievement orientation, personal charisma, pragmatism, and so on. It is contended that such qualities are simply not amenable for possession other than by birth and God's will. The manager makes decision and announces. The manager sells his decisions. The Manager presents his ideas and invites questions. The Manager presents a tentative decision subject to change. The Manager may present the problem, get the suggestions and then take his own decision. The Manager may define the limits and request the group to make a decision. The manager may permit full involvement of the subordinates in the decision-making process. It is often designated as 'Democratic leadership.'

There are various types of leaders in industry today. Messra, Alford and Beatty have classified them into the following categories :

Intellectual leaders, Institutional leaders, Democratic leaders, Autocratic leaders, Persuasive leaders, Creative leaders

Some of the common hindrances to leadership are as follows : (1) Certain leaders are not close enough to their followers to know or anticipate their reaction when now condition must be met. (2) Some are emotionally immature, resulting in loss of temper or other form of emotional instability when under pressure. (3) Some lack human understanding and, therefore, build antagonism instead of

friendship into their relations with others. (4) Some lack foresight, the ability to look ahead, to anticipate problems and to plan the work of the group. (5) Some are not big enough for their jobs and attempt to compensate for their feelings of inferiority by a superior attitude towards their followers.

QUESTIONS

1. What is leadership?
2. What are the characteristics of leadership?
3. Give the definition of leadership with meaning.
4. Explain the Greatman theory of leadership.
5. What is the role of leadership?
6. Classify the types of leaders.
7. Explain the techniques of leadership.
8. What are the functions of a leader?
9. Explain the qualities of leadership.
10. What are failings of individuals which affect their leadership.

11. COMMUNICATION

- 11.1 DEFINITIONS OF COMMUNICATION**
- 11.2 FEATURES OF COMMUNICATION**
- 11.3 NEED OF COMMUNICATION**
- 11.4 COMMUNICATION PROCESS**
- 11.5 COMMUNICATION PROCESS MODELS**
- 11.6 GESTURAL OR NON-VERBAL COMMUNICATION**
- 11.7 MODELS OF GRAPEVINE**
- 11.8 COMMUNICATIONS NETWORKS**
- 11.9 BARRIERS IN COMMUNICATION**
- 11.10 HOW TO MAKE EFFECTIVE COMMUNICATION**
- 11.11 HOW TO IMPROVE WRITTEN AN COMMUNICATION**
- 11.12 SALIENT FEATURES OF COMMUNICATION**
- 11.13 SALIENT FEATURES OF EFFECTIVE**

OBJECTIVE

After this unit you will be able to explain

- Understand Features, need, process, models of communication.
- Use of Non-virtual communication, models of Grapevine.
- Establish Communication network.
- Removing Communication barriers & make effective communication.

COMMUNICATION

11.1 DEFINITION OF COMMUNICATION

The concept of communication has been defined by some prominent management experts.

"Communication in its simplest form is a conveying of information from one person to another."

- Cyril L. Hudson

"It is the act of making one's ideas know to others."

-Fred G. Mayer

"The word communication is a way through which an organisation and its member shares meaning and understanding with another."

-Koontz and `O' Donnell

"The word communication describes the process of conveying messages, facts, ideas, attitude and opinions from one person to another so that they are understood."

-M.W. Commin

"Communication is the sum of all the things one person does when he wants to create understanding in the mind of another. It is a bridge of meaning. It involves a systematic and continuous process of telling, listening and understanding."

-Lours A. Allen

"Communication is an exchange of facts, ideas, opinions or emotions by two or more persons."

-Newan and Summer

"Communication is the process of passing information and understanding from one person to another.... It is the process of imparting ideas, and making oneself understood by others."

-Theo Haiman

11.2 FEATURES OF COMMUNICATION

From the analysis of these definitions following features of communication are revealed:

- Communication involves more than one person.

- It is transmission of facts, ideas, opinions, feelings and emotions from one person to another.
- there is a need of media for communication like speech, writing, painting and singing etc.
- It is a two way continuous process.
- The success of communication depends upon how effective ideas are being communicated, understood and responded.
- It is basis for action and co-operation.
- It includes all those means and efforts which one adopts to create understanding in the minds of others.
- It may travel from up and down and from side to side.
- It motivates and increases the morale of workers.
- It is required at all times and at all levels of management.

11.3 NEED OF COMMUNICATION

Communication is the backbone of an organisation. It can solve the problems of the organisation, it can even create problems for the organisation and for the officers are not perfect in communicating with the employees. It can lead to 'Industrial unrest and at the same time can bring Industrial peace.' Not only communication has got importance in the industrial set up but it has got significance in every sphere of life that may be social, personal and professional life.

In the present day business communication is indispensable. It has become part and parcel of every management. The success; prosperity and smooth working of an communication depends upon an effective system of communication in the organisation. Without effective communication a manager cannot perform his obligation well "Communication is as essential to business as blood to the human body." The success of the communication is the success of the business. The following points further justify the need or significance of communication.

11.3.1 Communication is must for smooth working of an organisation

The existence, working, success or failure of an organisation depends upon the quality of communication. All organisational functions are linked with communication. It is through communication which survives an organisation. It is needed from the inception of a business to its entire life. It can increase or decrease the industrial dispute in the organisation. Through internal and external communication process the organisation decides the various activities to be done and various objectives to be achieved.

11.3.2 Helpful to Management in Decision-Making

With the help of an efficient of communication like MIS i.e., Management Information System management can secure timely, relevant and useful information, data, facts and figures pertaining to various problems with which management can take with

confidence all major and minor decision. The quality for decision depends upon the adequacy and quality of information which is like input which can only be obtained with the help of an effective system of communication.

11.3.3 It leads to High Morale and Motivation

Motivation is key to success in the organisation. Motivated employees are the biggest assets for an enterprise. They not only achieve targets but even show result more than the targets. An efficient system of communication enables management to change the attitude, to motivate, to influence and to satisfy the employees. Proper graceful and soft communication reduces the points of friction and minimise differences. Good communication assists the workers in their adjustment with physical and social aspect of work. It is a basis of participative and democratic pattern of management.

11.3.4 Communication brings Co-operation and Co-ordination

Co-ordination means mutual understanding about the organisational goals the mode of their achievements and their inter-relationship between works being performed by various individuals. According to William H. Newman "Good communication aids in co-ordinating activities. Co-ordination and co-operation is required at all levels and for all activities of management. Present-day production and Administration is only possible through team spirit which only comes through co-operation and co-ordination. Communication is like a net through which all activities are united.

11.3.5 Communication is helpful in Delegation of Authority

The concept of Delegation of authority has become indispensable today in the large scale organisation. Delegation of authority is assigning responsibilities to different employees at different level. Delegation authority needs a well designed well drafted and well-presented communication. It helps in giving clear and timely guidelines, instructions and getting regular feedback and suggestions. No Communications. No delegation of Authority.

11.3.6 Communication leads to prompt decision and its implementation

In these days of tough competition one has to take best and prompt decision for which an efficient system of communication is must. Communication helps in gathering relevant and timely upto date information and date with which management can take best possible be implemented with full support of workers.

11.3.7 Communication Ensures an Effective Leadership

An effective leadership mean freely exchange of ideas, feelings, opinions and grievances between officers and subordinates. In an effective communication which is Multi-directional Communication

System officers are easy approachable by the workers and workers are equally free to talk and exchange their views with other workers. Effective communication is a step towards 'Worker's Participation in management' or it is an example of Industrial Democracy. Those officers who are of open mind, have soft

graceful and clear communication they can easily win their employees and can get their work done. On the other hand those officers who do not know the art of communication they are not popular with the employees. It is rightly said that "In communication it is only 30% what is said it is 70% how you say" so the success of leadership depends upon the way of presenting communications.

11.3.8 Communication increases the goodwill of the enterprise

As the personality and calibre of an individual can be known by the quality of his communication like wise the reputation and image of a company is known through the communication system available there. A regular and steady flow of information between employer and employee, between a company and its customers, its suppliers, the government bodies and the general public increases the reputation and good will of the company. In fact communication makes the relation between employer and employee thicker and healthy which adds to its reputation.

11.4 COMMUNICATION PROCESS

Communication is a regular process which keeps any organisation alive. It is like a flowing river. It is required at all levels, at all times to all people. The success of communication depends upon the quality of both the parties—sender and receiver.

Wherever, whenever, with whomsoever one has to communicate one has to cross these different stages of communication—three to be seen by sender and three by receiver and they keep on changing their roles.

11.4.1 Ideation or Source

Communication starts when one has got an idea, feeling, opinion, suggestion and problems. There must be some source for an effective communication. It is a thinking stage. It is rightly said, "Put your Brain in Gear before you open your mouth." It is thinking before saying do not enjoy a good reputation. Davis has rightly said, "Don't start talking until you begin thinking." People who talk without any idea or purpose are not welcomed.

Any neglect on the part of receiver may make the communication ineffective or it means the message is lost. In case of oral message, the receiver has to be good listener. Half reception is not reception. One can only enjoy the communication if reception is 100%. In reception only listening by the receiver is not enough he should be willing to understand also.

11.4.4 Decoding

Decoding mean the understanding the message by the receiver and to give response on it by participation. After receiving the message the receiver analysis the message to know the contents of message. He translates the symbols, figures or ideas so that he could properly understood the matter. It is opposite to Enconding. in decoding message is translated in a simple understandable language by the receiver.

11.4.5 Action

Action mean the response shown by the receiver on the message communicated by communicator. Receiver may ignore the message or store the information received or to perform the task assigned by sender or do something else. It may be positive if he accept it fully, it may be negative if the receiver ignore or refuse it. In some case it may be 'Netural' i.e., neither positive nor negative but it is simply postponed.

In final stage there is feedback. The sender receives the feedback from receiver. This may held the sender to evaluate the efftiveness of his message, so that sender can modify his subsequent messages. It is desirable step for an effective communication.

11.5 COMMUNICATION PROCESS MODELS

Communication models are abstract representations of the actual activities that occur from the time the sender of the message begins communication until the target of communication acts on it.

11.5.1 The simple Communication Model



11.5.2 The General Communication Model

The general communication model is a more complete description of the communication process, it is then applied to communication process between managers and subordinates.

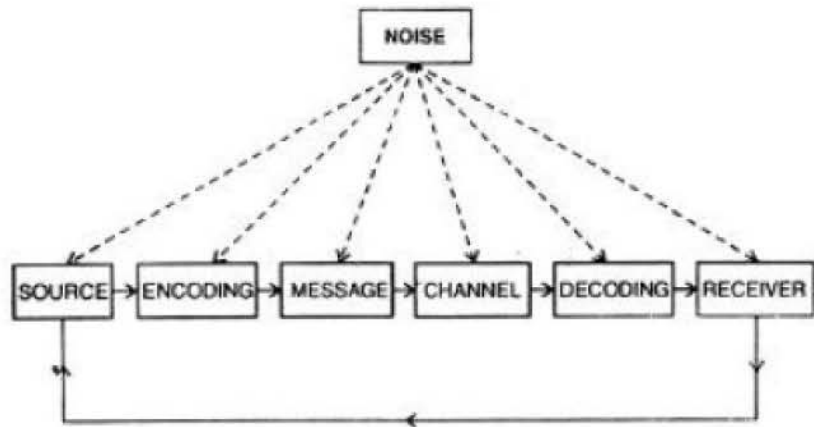

Fig. 11.2 Types of communication

11.5.3 On the Basis of direction

I. Downward or top to bottom communication

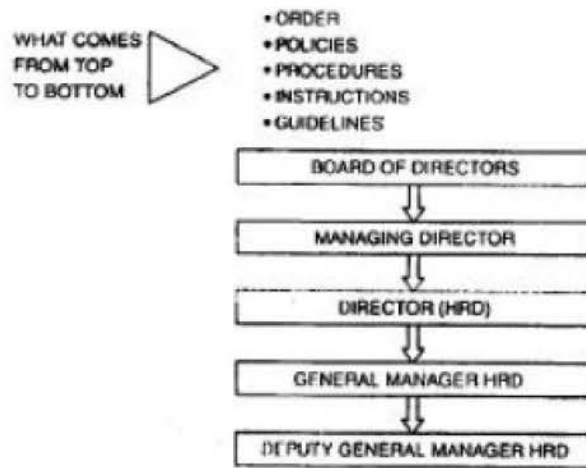

Fig.11.3

It takes place between superior and subordinates. Communication flow in line authority from top to bottom.

Through this communication Management convey its objectives, policies, rules and regulations, programmes and strategies to their subordinates working at different levels of the organisation.

II. Upward Communication or Bottom to top.

It is a communication from the workers to their immediate supervisor and from supervisor to higher management. In it reports, clarification, suggestions and grevances go from bottom to top, by a worker to his immediate Boss.

It has got the following advantages.

- (i) It motivates the workers and creates their interest through participation.
- (ii) It allows workers to put their suggestions and options.
- (iii) Workers can put their problems and grievances before the management.
- (iv) It leads the flow of better information from workers to the senior & leads better decision-making.

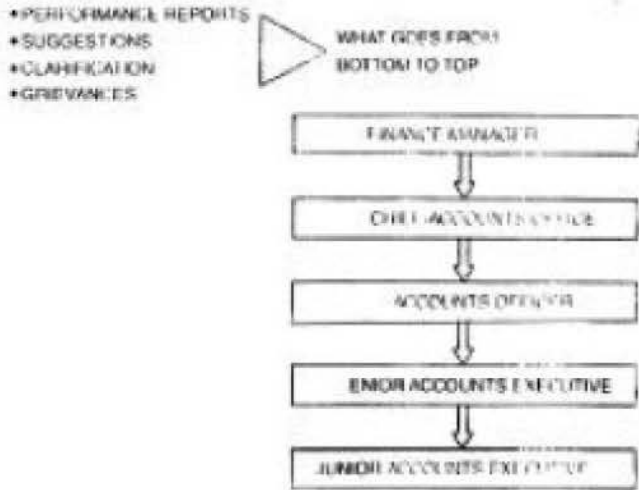

Fig.11.4

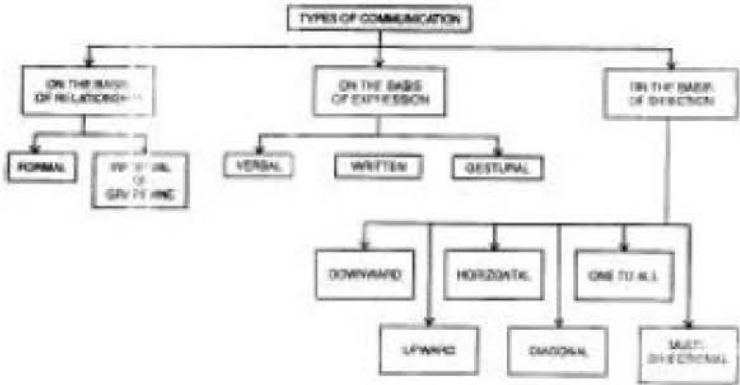

Fig.11.5

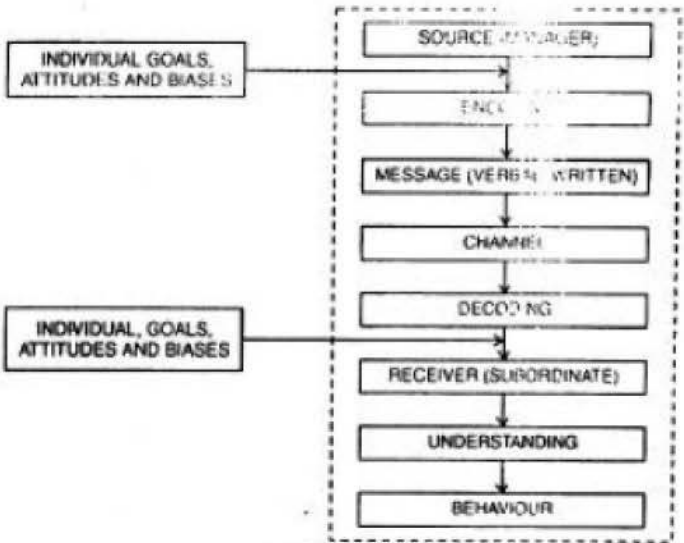

Fig.11.6

This model explicitly considers superior-subordinate relationships and gives greater insight into the nature and importance of communication in organisations.

Differences Between Downward and Upward Communication

Downward Communication	Upward Communication
<ul style="list-style-type: none"> • It is used to get things done through the subordinates 	It is used for giving the reports and other information from subordinates to upper level of management.
<ul style="list-style-type: none"> • It generally flows top level management to lower level management. 	It generally flows from lower level management to top level management
<ul style="list-style-type: none"> • It is used to communicate policies, procedures, orders and instructions to the subordinates. 	It is used to keep the superiors informed about the progress of work and other difficulties the employees in the execution of orders.
<ul style="list-style-type: none"> • It takes the form of the communication in letters, memos and company publication etc. 	It takes the form of activity, report, suggestions and complaints etc.

III. Horizontal or Lateral Communication

It is a communication from one person at one level in an organisation to another person at the same level. When two officers in a department or from other department have to share, or discuss some official matters this type of horizontal communication takes place.

Secondly when the company is doing correspondence with the outside agencies government or private or these agencies do correspondence with the company that is another example of horizontal or lateral communication.



Thirdly even when union do collective Bargaining with the management or management talks with them to know and to solve their problems and to listen their ideas, feelings and suggestions are the examples of horizontal and lateral communication. This type of communication must exist in the organisation for its smooth running and prosperity.

The horizontal communication is sometimes of an informal nature. Whenever a department head requires some information from another department head, he contacts him directly.

IV. Diagonal Communication

It is a communication which takes place between people who are neither in the same department nor on the same level of organisation is called diagonal communication.

Suppose if accounts Assistant talks with Manager Personnel on some issue would be known diagonal communication. This type of communication increases the organisational efficiency by speeding up information and cutting across departmental barriers.

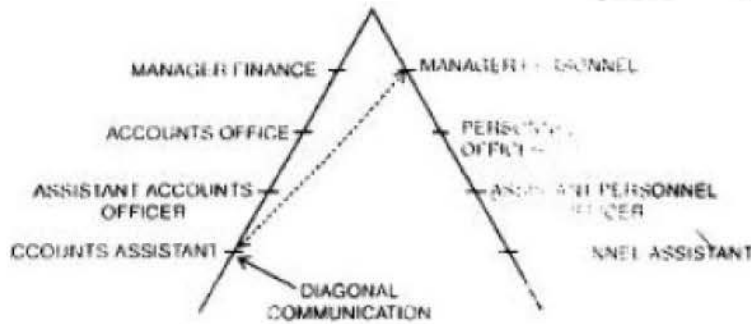

Fig. 11.7

V. Multi-Directional Communication

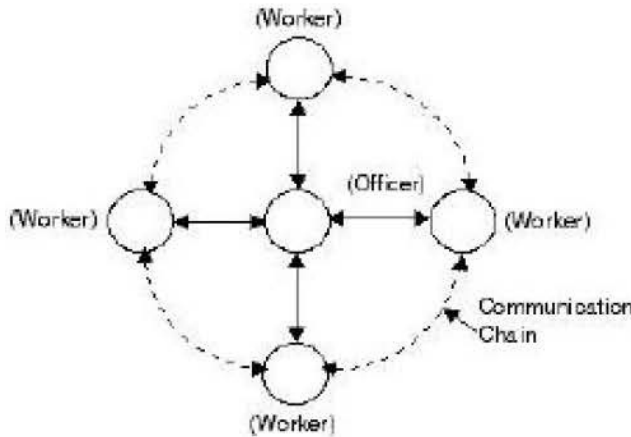

Fig. 11.8

It is a communication which takes place when the environment is highly Democratic in the organisation. Every workder can talk with his co-workers, they share their views, ideas, feelings, problems and they are also freely talking with their officers and the officers are also easy accessible to them. It is a rare example of Industrial Democracy.

Officers are in constant touch with the workers they try to know their problems, ideas and suggestion and give them due weightage.

Workers work in a very light environment, they feel quite comfortable during the stay in the organisations as their pressure and importance is duly felt. Here the communication is for the worker, by the worker and of the worker. This is the best and most idle type of communication.

VI. One to all Communication Structure.

This type of communication takes during conferences, seminars workshops, public speaking and class-room teaching. In this Mr. Managing Director address the Board or Shareholder's meeing. A training officer may address the trainee in a seminar or workshop or a teacher may teach his student in the class.

This type of communication is based on the medium used in the transmission of message and mutual understanding. Different media like workds, pictures and actions are used for exchanging information and understanding. Different media like words, pictures and actions are used for exchanging information and understanding

between different persons. The most important medium through which this type of communication takes place that is that the words. Besides words, pictures, models, diagram and gestures such as smile, silence, twinkling of eyes, movements of lips and facial expressions.

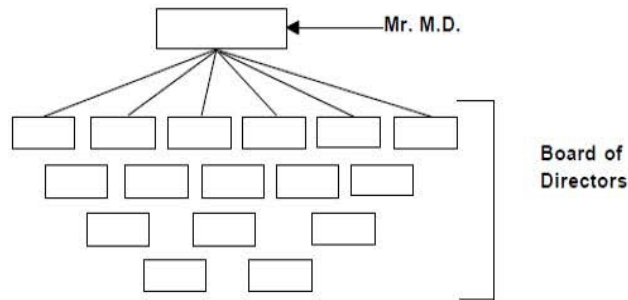

Fig. 11.9

On The Basis of Expression or Media

On this basis these are three media.

- Written Communication
- Oral Communication
- Gestural or Non-Verbal Communication

VII. Written Communication :

It is one of the formal system of communication. This is the only way communication for distantly placed persons and lengthy communication where records are to be kept must be written. Written communication ensures that everyone has the same information when matter is essential and complicated written communication is must. A written communication must be correct, concise, complete and clear.

Types of Written communication



Fig.11.10

Advantages

1. It is ideal way of transmitting lengthy messages.
2. It provides a permanent record of communication for future reference.

3. It can be quoted as a legal evidence in the court of Law in case of disputes.
4. It minimises the risk of any authorised alteration in the messages.
5. It is normally more clear, precise and correct.
6. It is only effective way of communication for passing of messages to far-off places where information is lengthy.
7. It is suited to convey messages to a large number of persons at one place and same time.

Disadvantages

1. It is generally more time-consuming.
2. It is also an expensive system of communication.
3. It is difficult to maintain a secrecy about a written communication, it can sometime be read even by an authorised people.
4. As there is no face-to-face discussion between the parties, hence doubt of the receiver may not be clarified.
5. It is very formal and lacks personal interest.
6. Sometime is seen that it becomes too lengthy, when messages are conveyed in writing.
7. It may lead to RED-TAPISM as it involves many formalities.

Oral or Verbal Communication

It is direct inter-personal contact between communicator and communicatee. This is communication by words of mouth. It includes communication through telephone, intercom and public speech. In every organisation, a great deal of information is exchanged orally.

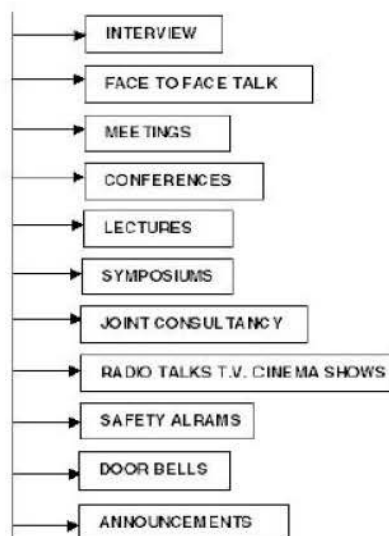

Fig. 11.11

"The Human voice can impart the message with meaning and shading which even long pages of written words simply cannot convey" rightly said to Tho Haimann.

Under this real meaning of message is conveyed by manner or tone of the voice or the facial expression of the communicator and communicatee.

Advantages

1. Verbal communication is more quicker and saves the time.
2. It establishes a personal touch which leads to greater understanding.
3. The main advantages of this communication is that it brings immediate reaction, motivation and response of the receiver.
4. It provides as the only means of conveying message in times of emergencies.
5. It is less expensive or economical as compared to written communication.
6. It enjoys many advantages due to more flexible and the message can be charged to suit the needs and response of the receiver.
7. Under this while communicating important points can be emphasised by the communicator.

Disadvantages

1. There is no permanent record of communication passing through this device.
2. It is less reliable.
3. There is a possibility in oral communication of being distorted.
4. It is generally influenced by self-interest and attitude of the people.
5. It does not provide enough time for thinking before conveying the message.
6. It is not possible to communicate with people when they are scattered over distant places.

11.6 GESTURAL OR NON-VERBAL COMMUNICATION

It is a type of communication which is neither written or oral. It includes everything that may be used to convey meaning from one person to another e.g., movement of lips or wink of an eye or the wave of hands may convey more than written or oral words. This is also known as "Body Language."

It is a communication through gestures or postures or through body language. It is often used to supplement the oral communication. It has got many media like facial expression, movement of eyes hands and lips. It is conveyed through feelings, emotions, attitudes,

reactions, movements and responses, e.g., when a Manager shakes hands with the subordinate or pats on his back, it conveys something important to the subordinate.

11.6.1 Advantages of Gestural Communication

1. This communication conveys the feelings, emotions, attitudes, reactions and responses in a minimum time.
2. In fact gestural communication is a supplement to oral communication. All advantages and disadvantages of oral communication applicable to even to gestural communication.
3. It is the communication through which people can be motivated, impressed and made attentive.

11.6.2 Meaning of Words in Communication

Kosen and sten are of the opinion that five important factors should be kept in mind about meaning of words.

- Words have many meanings
- Words sometimes have regional meanings
- Words develop new meanings
- New words are continually added.
- A difference in tone can change the meaning of a word.

In an effective communication of the meaning of words are not clear it is necessary to ask the sender what they mean.

Fabun has given two ways in which communication ambiguity may be reduced.

- Please do not assume that everyone knows what you are talking about.
- Please do not assume that you know what others are talking about without asking them questions, you can't be certain what they are talking about.

11.6.3 Non-verbal forms of communication

Body language. It is also known as "Kinasic Science which deals with understanding the signals which human body keeps on sending. It is communication without using verbal communication. Here one can convey every thing without saying any thing.

Any non-flexive or re-flexive movement of body can communicate something to the outside world often more honestly than verbal communication can the movement of eyes, lips, hands and other parts of bodies send and receive communication signal constantly.

Generally women are said to use fewer hand gestures than man do but engage in more direct eye contact. There are some examples of non-verbal message with their interpretation.

How to make Non-Verbal communication More Effective or.
Common Interpretations of Non-verbal communication Cues

WHAT YOU DO AND WHAT IT SAYS	
Noverbal Message	Typical Interpretation
• Making direct eye contact	Friendly, sincere, self-confident, assertive
• Avoiding eye contact	Cold, evasive, indifferent, insecure, passive, frightened, nervous, concealment
• Shaking head	Disagreeing, shocked, disbelieving
• Patting on the back	Encouraging, congratulatory, Consoling
• Scratching the head	Bewildered, disbelieving
• Smiling	Contented, understanding, encouraging
• Biting the lip	Nervous, fearful, anxious
• Tapping feet	Nervous
• Folding arms	Angry, disapproving, disagreeing, defensive, aggressive
• Raising eyebrows	Disbelieving, surprised
• Narrowing eyebrows	Disagreeing, resentful, angry, disapproving
• Wringing hands	Nervous, anxious, fearful
• Leaning forward	Attentive, interested
• Slouching in seat	Bored, relaxed
• Sitting on edge of seat	Anxious, nervous, apprehensive
• Shifting in seat	Restless, bored, nervous, apprehensive
• Hunching over	Insecure, passive
• Erect posture	Self-confident, assertive

Human Actions. As it is popularly said "Action speaks louder than words". It is important to understand that what an individual says can be reinforced or contradicted by body language. Human Action should support the verbal message but it does not always do so. For instance an autocratic manager may pound a fist on a table while announcing that firm now we will follow a participative management. Such contradictory communication will certainly create a "credibility Gap".



Fig.11.12

**(Source : Hopper Robert & Whitehead Jack
"Communication concepts & skills" New York `1979 p. 118.)**

11.6.4 Role of credibility

If there is lack of credibility which means when there is lack of sufficient trust, confidence and faith between communicating parties then selective listening takes place resulting in ineffective communication. None of the parties exchange complete information.

Due to withholding of communication by one or both parties will further aggravate the trust issue and adversely affects interpersonal problems.

In those situations where creditibility level is low, due to low trust level, several types of "noises" enter the communication process like "Superficial" touch in the communication. This happen due to insincerity in the parties. If mean when parties Do not walk with their talk, they simply talk with their talk".

When there is lack of trust, faith and confidence among the parties which implies that what is being communicated or the one who is communicating can not be trusted. The essence of effective communication is that the message transmitted by superior to subordinates should not be understood but also believed by latter.

In fact distrust, threat and fear undetermine communication. In climate containing therefore is, any message will be viewed with suspicion. In the light of threats, whether real or imaginary, people tend to tighten up become defensive and distort information. Fear of being misinter-preted fear of exposing oneself to criticism are etc a vital barriers to effective communication and adversely effective the creditibility of the communication.

11.6.5 Symbols in Communication

The study of communication symbols is included in the science of senantics. Symbols are sign of instant communication.



Fig. 11.13

Traffic symbols are more or less standard every where and even symbol for smoking toilet, and Restaurant.

Source : Communication & Communication System Richard D. Ivawm Homewood.

Symbolic Communication

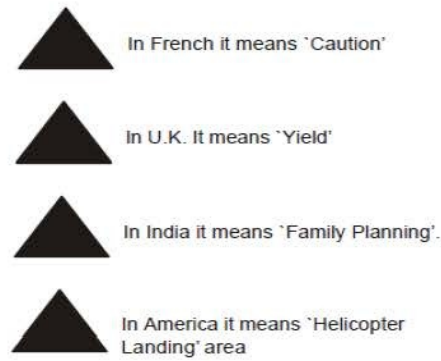

Fig.11.14

Hotel Information or any information as has been shown in the above mentioned model.

But sometimes symbols have got different meaning in different parts of the world. For example symbol of triangle creates a communication

Through symbol communication can be made more effective like (i) two or three dimensional diagrams or model. (ii) Blue-print, posters, charts,

motion picture and graphs can convey more and strong meaning in some situations than the words.

On The Basis of Relationship

- Formal Communication
- Informal Communication or Grapevine

11.6.6 Formal Communication

Meaning. It is associated with formal organisation structure. It travels through formal channel. It is an effort through this type of communication to regulate the flow of organisational communication. So as to make it more orderly and to ensure smooth accurate and timely flow of information. **It is official Communication among officials for solving official problems.**

It is deliberately and consciously established by the management. It is based on formal systems of authority. Formal communication are generally in the form of policy manuals., procedural hand books, memoranda, orders, scheduled meetings and conferences, special interviews, company news, bulletins or information regarding promotion, suspension and termination of employees etc. Formal communications are authentic, written and communicated through formal scalar chains.

Formal communication flows in three directions that is upward, downward and horizontal.

Features

- (i) Communication of authorised and authentic information.
- (ii) This communication in writing.
- (iii) In it there is proof of receiving communication.

(iv) It is communication of message through scalar chain.

Advantages

- It is proper and systematic.
- It ensures orderly flow of communication.
- It helps in fixing responsibility.
- It helps in locating the source of communication.
- It helps in managing and controlling business affairs.
- It helps in establishing contact with distant parties.

11.6.7 Limitations of Formal Communication

Formal communication suffers from the following limitations :

- It is slow moving communication system.
- Personal warmth and touch is lacking in formal communication, because it generally establishes impersonal links and relationship.
- It generally overloads higher authorities with work.
- In it Free and Frank opinion cannot be expressed just to avoid criticism and confrontation.
- It has to follow certain established rigid rules and has to face hurdles in the flow of information.

11.6.8 Informal Communication or Grapevine

This type of communication is free from all formalities planned in an organisation. No formal organisation chart is followed to convey message. It is based on informal relationship between the two parties-sender and receiver. It is the result of the natural desire of the people to communicate each other when interaction takes place among them, small groups emerge spontaneously for the purpose of social satisfaction and they develop their own communication system called the informal communication system or the 'Grapevine'. Under this system, organisational and personal matters are discussed. Information under this system may be conveyed by a simple glance, gesture, nod, smile or mere silence too. It is not the result of any official action but of the operation of personal, social and group relations of the people. It co-exists alongwith the formal communication and supplements it.

11.6.8.1 Features

1. It satisfies the employee's needs to have friendly relationsh with their colleagues.
2. It acts as a safety valve, when workers are full of feelings they use grapevine to express their anxieties and inner feelings.
3. The information generally transmitted in it may be in accurate, a rumour, a gossip or a private talk.
4. It cannot be avoided. If suppressed at plane, it will take place at another place.
5. It spreads like a wild fire.

6. Through it workers make some sense of humour and feel relaxation.
7. In it generally those people are discussed who are not present there. It provides a real picture of their personality.
8. It is used to spread messages which the management wishes to convey to its employees and to counter the rumours.

11.6.8.2 Advantages

- (i) It develops friendly relations and fellow feelings among workers.
- (ii) It operates with greater speed and spreads very quickly.
- (iii) In it there is Free and Frank expression of views.
- (iv) It reduces tensions in employer-employee relations and provides emotional relief to workers.
- (v) Employees' reactions, responses and attitudes can be easily ascertained under this type of communication.

11.6.8.3 Disadvantages

- (i) Informal communication consists of unconfirmed facts, half truths, rumours and distorted information.
- (ii) It is not possible to fix responsibility for its source of origin or flow of information.
- (iii) This type of communication sometime may harm the organisation due to inaccurate information.
- (iv) It spreads rumours and develops misunderstanding.
- (v) In it there is distortion of facts because different persons pass on the information with their own outlook and interpretations.

11.7 MODELS OF GRAPEVINE

Informal communication also known as 'Grapevine'. It usually transmits information about what people are doing and feel towards a particular situation or think about the management.

There is no formal path of grapevine communication. Keith Davis has identified four different networks for transmitting information through the grapevine as follows.

11.7.1 Single or straight line chain Model

As it is clear from the model No. 1 that 'A' has communicated with high confidence some secrets/private affairs/weaknesses of his boss to 'B' by saying that I am only sharing these things with you in confidence but please do not share with anybody. But 'B' feels after knowing the information from 'A' that how he can ignore his very close friend 'C' 'B' says to 'C', I am only telling to you but please do not share it with anybody, but likewise 'B', 'C' also shares that talk with 'D' who further shares it with 'E' and within few hours every employee working in that organisation come to know what that talk.

11.7.2 Cluster model of Grapevine

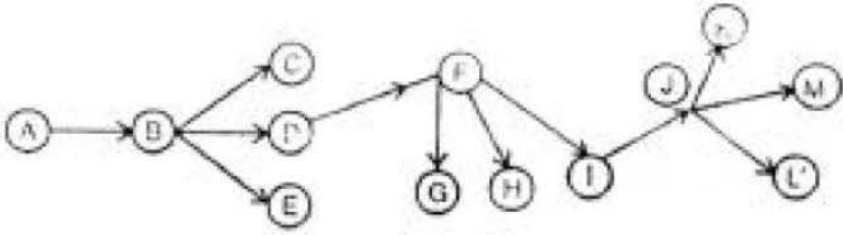

Fig. 11.15

This model has got much faster speed as compared to straight line model of grapevine. As it is clear from the model No. 2 an employee e.g., 'A' has shared some information to all the employees working in the accounts Department where B, C, D, E are working and 'D' has further given that information to Production Dept. employees F, G, H, I and I has further shared it marketing Deptt. people J, K, L, M and in this way information reaches within two hours to all the employees working in different departments and every employees working in different departments and every employee will know it in very short time of two three hours.

11.7.3 Star or Gossip Pattern of Grapevine

This is known as the fastest model of grapevine. In this Model No. 3 suppose 'X' is P.A. to Managing Director.

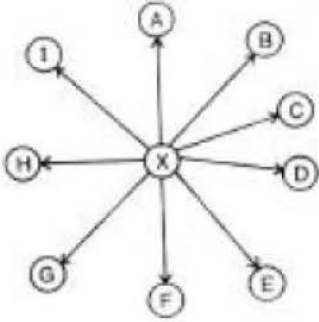

Fig.11.16

He happens to know that during this year Mr. M.D. is going to announce a Bonus of 20%. He wants to share this information with all the employees, in that case 'X' would be sharing that good news with all the employees in a gathering form.

11.7.4 Probability pattern chain model

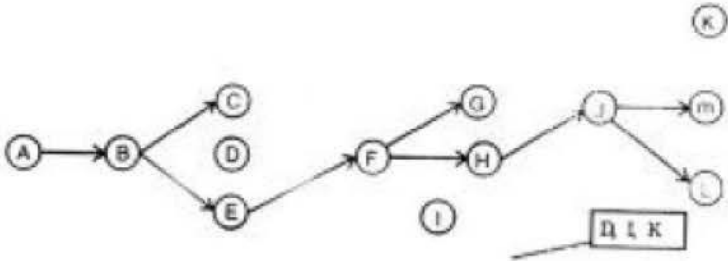

Fig. 11.17

This model of grapevine is based on the principle of probability. In this model No. 4 'D', 'I', 'K', could not get the information due to various reasons. There is always probability that all employees may not get all the information e.g., 'D' could not get the information as

he is a person with a cool, submissive nature being not much social he could not know what other people were discussing. 'I' could get the information as he happens to be Pro-management, he does not want to listen and to sit with those employees who are discussing anti-management policies. 'K' could not get the information as he happens to be physical or mentally absent on that occasion when these information were being discussed.

Difference between Formal and Informal Communication

Nature of difference	Formal	Informal
1. Verbal and Written	It is a written communication	It is verbal communication.
2. Direct and Indirect	It is based upon indirect written documents	It is based upon direct gestures and verbal talks.
3. Scalar Chain	It follows the principles of scalar chain.	It does not follow the principles of scalar chain.
4. Proof	In it the proof of sending communication is kept.	There is no proof for sending it.
5. Relations	It is the result of authorities granted and duty assigned by the employer	It is the result of very intimate relation between employees.
6. Rumours and Mis-understandings	Messages are clear in writing and as such, there is no cause for rumour or misunderstanding.	Informal nature of communication which spreads rumours and creates misunderstanding.
7. Authenticity	Messages are authentic under this	Message may not be authentic

CHECK YOUR PROGRESS

1. Write the advantages of communication

.....

.....

.....

.....

.....

11.8 COMMUNICATION NETWORKS

It represents the pattern of contacts among members of the organisation. It may be of these type :

- Wheel Communication Network
- Circular Communication Network
- Free Flow Communication Network
- Chain Communication Network
- 'Y' Communication Network

11.8.1 Wheel Communication Network

It represents the pattern under which the subordinates can communicate with and through one manager. It is called a wheel network since all communications pass through the manager who acts as a central authority like a hub of the well.

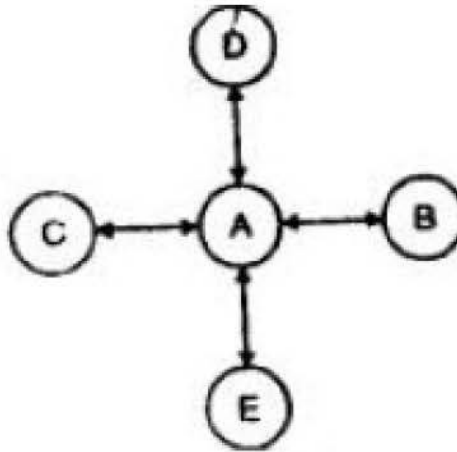

Fig.11.18

11.8.2 Circular Communication Network

In this, the message moves in a circle. Each person can communicate with his two neighbourhood colleagues only. A disadvantage is that it is very slow.

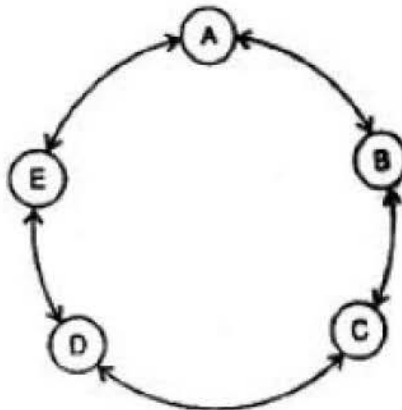

Fig.11.19

11.8.3 Free Flow Communication Network

In this, there is no restriction on the flow of communication. Everyone is free to communicate with anyone and everyone in the organisation.

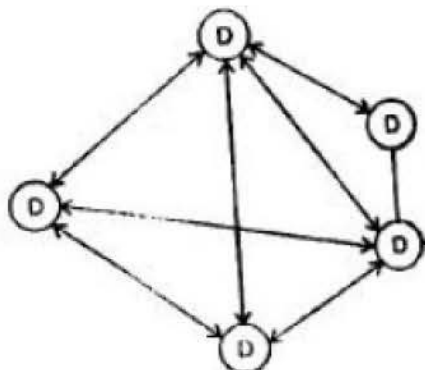

Fig.11.20

11.8.4 Chain Communication Network

The chain rigidly follows the formal chain of command. In this, one person transmits information to another as per chain in the organisational hierarchy.

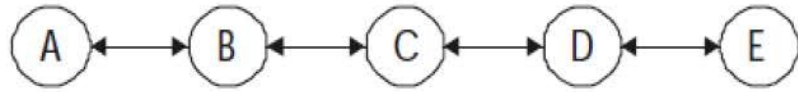

Fig.11.21

11.8.5 'Y' Communication Network

In this, two people report to a superior or boss who occupies two positions.

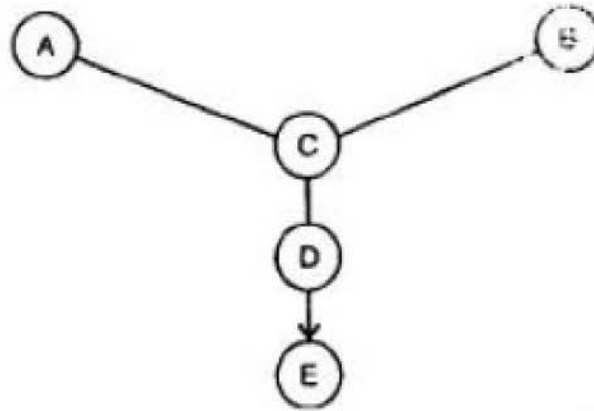

Fig.11.23

Level of Communication

For the effectiveness of communication one must understand the different communication levels. Experts are of the opinion that there are four levels of communication like

- Conventional level
- Exploratory level
- Participative level
- Confrontive level

(**Source** : Process of Communication Berlo. David K. Pinchart & Winston New York.)

11.8.5.1 Conventional level

It is a very impersonal level of communication which is being used with strangers for casual acquaintances. It is the start of communication and is a conventional desire to be polite or get acquainted to fill silences or to seek or convey incidental information of relieve tension. It generally includes remarks like "How do you do", "Do you have time" and "Good morning, Sir," or "May I come disturb you" etc. It simply acknowledges the presence of the other person may open the door for further communication. It is very important to take due care at this level of communication.

11.8.5.2 The Exploratory Level

It is second level in a communication which is fact presentation and problem-oriented stage. Even at this level normally the

communication is impersonal. Here things, people, problems, opportunities theories or accidents are discussed. Things and differences are simply discussed and delivered e.g. Information at meetings, Seminars conferences and in classrooms are provided.

11.8.5.3 The Participative Level

This level at which people talk about themselves and engage in self-disclosure and disussion. People express their opinions, feelings, problems, describe their own experience. Here minds are kept open, ideas are listened and understood. Here minds are kept open, ideas are listened and understood. This is semi-personal level of effective communication. But the success of communication at this level leads to success at other stages of communication.

11.8.5.4 The Confrontive Level

This is very deep and sensitive level of communication and in fact the last level. Here people freely enagage in self-disclourse. They reveal themselfe, express themselves and intimacy takes place. In fact at this level of communication there is battiers, no formalities very very personal stagelevel of communication. Normally people do not reach/enjoy this level of communication. This type of communication generally takes place among very close friends levels and married couples.

11.9 BARRIERS O R PROBLEMS I N COMMUNICATION

A defective communication can create many problems in every sphere of life and on the other hand an efficient system of communication can solve all problems. It can make an organmisation or can break it. It can bring your employees closer to you and even can keep your employees away from you. It can run your business or ruin your business.

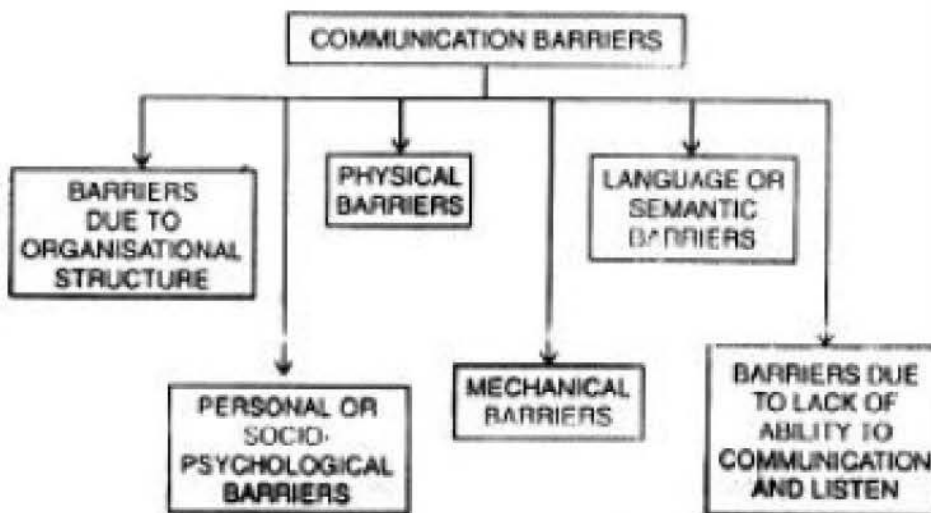

Fig.11.23

Communication can be said as to be No-I management problems. It serves as the lubricant fostering for the smooth operations of the management process. It is seen that generally all messages in an

organisation are not effectively transmitted or received. There can be many obstructions, blockages, hurdles, stoppage or bottlenecks in an effective system of communication, which are known as Barriers in Communication.

Whenever there are any type of barriers in the communication there is bound to be misunderstanding and conflicts among the people. It is seen that normally a large number of managerial problems is the result of ineffective or faulty communication. It is always desirable for the management to get remove these communication barriers as early as possible.

11.9.1. Barriers due to organisational structure

In a big organisation there are several layers in the structure and the chances for information being filtered or twisted are more there. Likewise information received from the top may not reach bottom in the same shape to the communication as per his liking and interest. In fact the people between top and bottom ends act as communication filters. They may add colour to the information. Due to which officer at the top level may not know the exact problem, feelings, ideas and opinions from the people at operational level, the communication keep on changing shape from every hand it passes and same is the case when information has to come from top to bottom.

11.9.2 Barriers due to status, Ego and Position of officers at top level.

It is seen that frequency of communication is less at the top level as compare to lower level. When workers go to their senior officers, the status, ego, position and their authority comes in the way of effective communication. Officers do not freely and frequently talk with their subordinates. Either these officers are busy or they pose to be busy and do not listen to their employees, they are ignored and then workers stop going to them.

11.9.3 Personal or Socio-Psychological Barriers.

It is seen that normally it is due to personal or socio-psychological reasons which effects communication. Social values, inferiority complex, biased approach, sentiment, attitude, affects the quality of communication. Persons differ in their motives, attitudes and sentiments. There may also be a problems of encoding and decoding others sentiments and ideas. The interest of people differ and so is the communication. A problem may be important for one person but may carry no weight for another.

In the absence of adequate self-confidence or fear for retaliation may restrain the expression of the free ideas. If we happen to think a person to be fool any message from him is looked upon only in that spirit.

Division of people into different classes, castes and communities also affects communications, ideas and view-points. In an organisation if it is dominated by person of certain castes and communities and those belonging to minority group may have less opportunities of being attended and heard.

11.9.4 Physical Barriers.

Sometimes it is found that communication is also affected by environmental factors which reduces the sending or receiving qualities of communication. Communication becomes difficult or poor due to physical distance, distracting noise, bad weather like heavy rain or storm. For an effective communication one needs proper distance environment and surroundings.

11.9.5 Mechanical Barriers

It refers to the all those problems which arise in a communication due to some mechanical defects in all those instruments which are being used in the communication e.g., if there is some mechanical defects in Telephone, Inter-com, PBX or any other media of communication that is going to effect the quality of communication.

11.9.6 Sementic or language Barriers

Sementic is the science of meaning. Words have got no meaning it is we who give them meaning. It arises due to limitation of symbolic system. Symbol may have different meaning which differ from country to country, culture to culture. Symbols may be classified as language, picture or action.

Langauge or words are the principles communication instrument of all employees. A major difficulty with language is that nearly every common word has got several meanings, unless the context or reference is known one is free to accept any one of meaning as per one's desire.

Pictures are also one of the type of symbols. Pictures are worth thousand words. Sometime a picture may create confusion in the mind of observer.

Action or non-verbal communication is another type of symbol. To do or not to do both have meaning e.g., if an employee wishes, "Good Morning" to his officer the smile or absence of it, wishing or not wishing have both meaning. It is well known that "Action, speaks louder than words". If an officer say something or do something else it is found that people do not listen to officer.

11.9.7 Barriers due to lack of ability to communication

In order to communicate effectively, it is very essential to have command on the communication. People who do not enjoy command on communication, they can not be a good listener and lack clarity. The message should be adequate and appropriate to the purpose of communication.

11.9.8 Barriers due to Inadequate Attention

No attention or inadequate attention to the message makes communication less effective and the message is likely to be misunderstood. Not to read notices, Minutes Reports is a very common feature which makes the communication ineffective.

In words of "Joseph Dooher," listening is the most neglected skill of communication. Half listening is like racing your engine with gears in neutral. Half listening is no listening.

11.9.9 Barriers due Premature Evaluation

It is normally seen that some officers have got a tendency to form a Judgement before listening to the entire message. Understand the problems, situation, ideas before you take your decision or do evaluation. Think before speaking or taking any action.

11.9.10 Barriers due to Resistance to change

It is common feelings among employees to stick to old and customary patterns of life. Most of the people do not want any change in their routine life. Whenever any scheme which is going to affect their old working system, they resist to change and do not want to listen any talk on that which affects the communication. Secondly when there is a lack of mutual trust between the communicator and the communicatee, the message is not followed. Creditibility Gaps i.e. inconsistency in saying and doing is also a obstacle to on effective communication.

11.10 HOW TO MAKE EFFECTIVE COMMUNICATION

Communication is very sensitive aspect. "It is like a double edge weapon if not properly used it can harm the user." Effective communication is very essential for the success of an organisation.

In order to remove the barriers of communication an open door communication policy must be prepared and followed by the manager in the organisation. There must provide an atmosphere of trust and confidence in the organisation. The following are the important methods of an effective communication system.

11.10.1 To strengthen the communication Network

In order to improve the communication network, the communication procedure should be made simple. Layers in the communication channel should be minimised. Go for delegation of authority and decentralisation, frequent meeting, conferences and discussions should be arranged to have full participation of the worker.

11.10.2 To Allow Two-way communication

A good communication should flow frequently from top to bottom to top. There must be a sound feed back system so that the manager could know whether his order or instructions are being followed or not.

11.10.3 To select the Right Media of communication

The success of communication depends upon selection of right media. Right message must reach to the right person at right time. For those type of communication for which permanent record has to be kept formal written channel of communication should be adopted like written agreement and Books of accounts etc. In case of personal type of communication informal light mode of communication should be adopted.

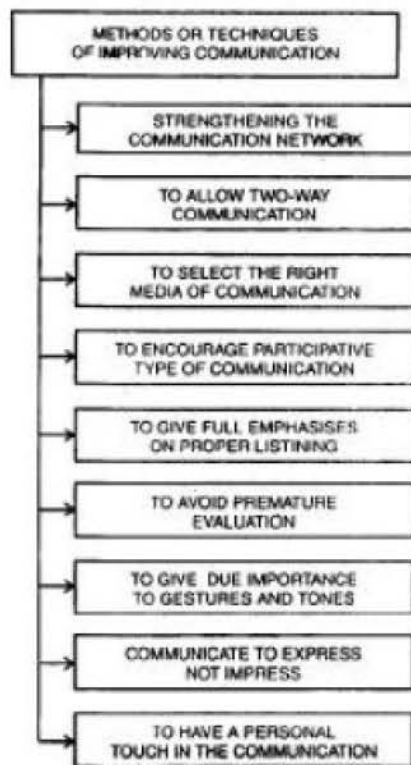

Fig.11.24

11.10.4 To encourage participation of communication

The management should promote the participative approach in managing the affairs. Subordinates should be invited to participate in the decision making process. Good communication is based on mutual trust full workers participation, collective bargaining, cooperation and team spirit. It will bring co-ordination and reduce many communication barriers.

11.10.5 To Give proper emphasis on proper listening.

Most of the people are very selective listener. Listening only comes when there is a interest of the listener. Talk in the language of the listener and of their level. For that communication must be clear, complete, concrete concise, and correct. This will lead to proper interest of the listener and it would be interpreted in the sense is which the sender wants to convey.

11.10.6 To Avoid Pre-mature Evaluation

It is seen that some people have the tendency to form of judgement before listening to the entire message which is due to pre-mature evaluation. It should be avoided as it may lead wrong decision and judgement. It distorts understanding and acts as a major barrier in an effective communication. Listen your people with full patience and attention. Problem properly listened leads to solving it in a better manner.

11.10.7 To give due importance to gestures and tones

Gestures and tones are known as 'Body Language' which is a non-verbal communication. People communicate meanings to others with their bodies during inter-personal interaction. It is technique to

communicate the message with the movement of the whole body or part of it. Facial expression, movement of hands are the usual symbols which must be used to make the communication effective. Gestures like eye movement, smiles, frowns, touching, closeness, breathing and odour can add colour to the communication and it becomes lively.

11.10.8 Communicate to Express not to Impress

It is golden rule for an effective communication, Always communicate to express not to impress, it means while communicating simply and only concentrate on your expression delivery of words, selection ideas and subject matter. Do not bother about impression. Do not bring any type of artificial touch in the communication. If your expression is good impression is bound to come. Be original in communication.

11.11 HOW TO IMPROVE WRITTEN COMMUNICATION

Effective writing may be exception rather than rule, nor do education and intelligence guarantee good writing. Common problem in written communication is that writers use too much difficult words, and use poor grammar, ineffective sentence structure and incorrect spellings.

Guidelines to be kept in mind to improve written communication.

- Use simple words and phrases.
- Use personal pronouns such as "You" whenever appropriate.
- Use short and familiar words.
- Use short sentences and paragraph.
- Give illustrations and examples.
- Make use of charts, models graphs and computer representation.
- Avoid unnecessary words.

11.12 SAILENT FEATURES OF GOOD COMMUNICATION SYSTEM

A good communication system has certain essential characteristics which, if a communication system has, there would exist a good and an effective communication system.

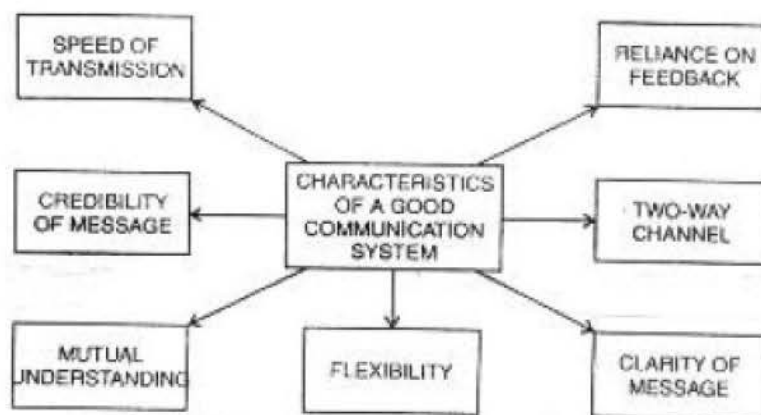

Fig. 11.25

11.13 SAILENT FEATURES OF EFFECTIVE COMMUNICATION

In order to make communication affective following principles or guidelines/factors should be kept in mind.

11.13.1 Principles of clarity

The begining of all communication is some message. The message must be as clear as problem. No ambiguity should creep into it. The message can be canveyed properly only it has been clearly formulated in the mind of communicator. Clarity bring clarity confusion brings confusion. It should be kept in mind words do not speak themselves but the speaker gives them meaning.

11.13.2 Principles of Consistency

It emphasises that communication should always be consistent with plans, objective policies and rules and regualtions of the organisation. There should not be and confusion and conflict. Inconsistent message always creates Chaos and confusion in minds of people which is highly known as against interest of the enterprise.

11.13.3 Principles of Completeness

Also the principles of Adequancy which gives emphasis that information should be adequate and complete in all aspects lack of which delays actions and destroys understanding and relations of the parties.

11.13.4 Principles of Timeliness

Information or ideas should be communicated at proper time. Any delay in communicating the message will serve no purpose except to make the messages more historical documents as they loose their imortance and effectiveness by the lapes of time.

11.13.5 Principles of Integration

In fact communications is a means not an end in itself. It should promote cooperation among people at work to achieve the organisation objectives it is only problem when individual objectives are intregated with organisation objectives

11.13.6 How to make Written Communication Effective?

John Fieldon is of opinion :-

- Use a forceful style in writing when writer has power but his tone should be polite but firm.
- Use passive style when writer is in a position lower than that of receiptient of the message.
- Use personal style of communicating i.e., requests for action.
- Use impersonal style it is suitable for conveying negative information.
- Use lively or colourful style for good news items, advertisement and sales letters.
- Use less colourful style for continuing impersonal passive and for common business writing.

"Communication in its simplest form is a conveying of information from one person to another." Communication is the backbone of an organisation. It can solve the problems of the organisation, it can even create problems for the organisation and for the officers are not perfect in communicating with the employees. It can lead to 'Industrial unrest and at the same time can bring Industrial peace.' Not only communication has got importance in the industrial set up but it has got significance in every sphere of life that may be social, personal and professional life. Communication is a regular process which keep any organisation alive. It is like a flowing river. It is required at all level, at all time to all people. The successes of communication depends upon the quality of both the parties-sender and receiver. The general communication model is a more complete description of the communication process, it is then applied to communication process between managers and subordinates. written communication is one of the formal system of communication. This is the only way communication for distantly placed persons and lengthy communication where records are to be kept must be written. Written communication ensures that everyone has the same information when matter is essential and complicated written communication is must. A written communication must be correct, concise, complete and clear.

Oral Communication is direct inter-personal contact between communicator and communicatee. This is communication by words of mouth. It includes communication through telephone, intercom and public speech. In every organisation, a great deal of information is exchanged orally.

Gesture is a type of communication which is neither written or oral. It includes everything that may be used to convey meaning from one person to another e.g., movement of lips or wink of an eye or the wave of hands may convey more than written or oral words. This is also known as "Body Language."

The study of communication symbols is included in the science of semantics. Symbols are sign of instant communication. Traffic symbols are more or less standard every where and even symbol for smoking toilet, and Restaurant.

QUESTIONS

1. Give the definition of communication with the meaning.
2. What are the features of communications.
3. Why communication is required?
4. Explain the process of communication.
5. What are the various models of communication? Explain each.
6. Differentiate between verbal and non-verbal communication.
7. What are types of communications based on relationship? Explain.
8. Explain the various models of grapevine.
9. What do you understand by communication network? Explain the various networks.
10. Explain the problems in communication.
11. What are important points to be kept in mind to improve an effective communication?
12. What are the salient features of an effective communication?

12. ACCOUNTS FOR SMALL ENTERPRISE

- 12.1 HOW ACCOUNTS ARE MAINTAINED?**
- 12.2 LEARNING OBJECTIVES**
- 12.3 NEED OF ACCOUNTING**
- 12.4 MEANING OF ACCOUNTING**
- 12.5 OBJECTIVE OF ACCOUNTING**
- 12.6 ACCOUNTING PROCESS**
- 12.7 JOURNAL**
- 12.8 WHAT IS AN ACCOUNT?**
- 12.9 LEDGER**
- 12.10 TRIAL BALANCE**
- 12.11 FINAL ACCOUNTS**
- 12.12 PROFIT AND LOSS ACCOUNT**
- 12.13 BALANCE SHEET**
- 12.14 ACCOUNT FROM INCOMPLETE RECORDS**

OBJECTIVE

After this unit you will be able to explain

- Understand the need of accounting
- Maintaining accounts
- Device objectives of accounting.
- Know about Ledger, trail, balance, balance sheet

ACCOUNTS FOR SMALL ENTERPRISE

12.1 HOW ACCOUNTS ARE MAINTAINED?

- Need for Accounting
- Meaning of Accounting
- Objectives of Accounting
- Accounting Process
- Journal
- Ledger
- Trial Balance
- Final Accounts
- Accounts from Incomplete Records
- Let Us Sum Up.

12.2 LEARNING OBJECTIVES

On completion of this chapter, you should be able to :

- Appreciate the need for accounting in small scale enterprises.
- Define accounting.
- List the objectives of accounting.
- Identify the stages/process involved in accounting.
- State the meaning of book - keeping, Journal and ledger.
- Describe Trial Balance.
- Prepare Final accounts, i.e., Profit and Loss Account and Balance Sheet.
- *Prepare final accounts from incomplete records.

You have so far studied from the genesis of an idea to establish a small scale enterprise to its actual establishment and operation. You also know that business is undertaken mainly with profit motive. Hence, the entrepreneur now needs to know whether his/her business earned profit or incurred loss over a period of time and how is the financial position of the business. These questions are answered by accounting. In this chapter, we intend to discuss accounting for small enterprises in its various aspects like the need for and objectives of accounting, stages involved in accounting, preparation of final accounts, etc.

12.3 NEED OF ACCOUNTING

Running a business involves a large number of transactions to achieve its main objective, i.e., to earn profit. In a business, various items are purchased and sold frequently. Payments are made and received every now and then. Amounts are to be received and paid to various parties time and again. An entrepreneur cannot remember the exact details of numerous transactions taken place during a period of time. Because, there is a limit to human memory. But, the entrepreneurs has to remember all transactions so as the profit earned or loss incurred the business during the period could be ascertained. This necessitates the recording of transactions taking place from time to time. The recording of business transactions in a systematic manner is the main function served by accounting. As a matter of fact, accounting is necessary not only for business organisations, but also for nonbusiness organisations like educational institutions, hospitals, clubs etc. Here, we especially concentrate on accounting for small business enterprises.

12.4 MEANING OF ACCOUNTING

What is accounting? Different scholars and Institutes have defined accounting differently. The important among them are as follows :

- According to Smith and Ashburne, "Accounting is the science of recording and classifying business transactions and events, primarily of a financial character and the art of making significant summaries, analysis and interpretations of these transactions and events and communicating results to persons who must take decisions or form judgement."
- The Committee on Terminology, Appointed by the American Institute of Certified Public Accountants defined accounting as, "Accounting is the art of recording, classifying and summarizing in a significant manner and in terms of money, transactions and events which are, in part at least of a financial character and interpreting the results thereof."
- In fact, this is the popular definition of accounting that outlines fully the very nature and scope of accounting activity. The sum and substance of accounting, thus, is from the recording of transactions to communicating the results thereof to the concerned parties.

12.5 OBJECTIVE OF ACCOUNTING

The following are the main objectives of accounting :

12.5.1 To maintain full and systematic records of business transactions

Accounting is the language of business transactions. Given the limitations of human memory, the main objective of accounting is to maintain a full and systematic record of all business transactions.

12.5.2 To ascertain profit or loss of the business

Business is run to earn profits. Whether the business earned profit or incurred loss is ascertained by accounting by preparing Profit & Loss account or Income Statement. A comparison of income and expenditure gives either profit or loss.

12.5.3 To depict financial position of the business

A businessman is also interested in ascertaining his financial position at the end of a given period. For this purpose, a position statement called Balance Sheet is prepared in which assets and liabilities are shown. Just as a doctor will feel the pulse of his patient and know whether he is enjoying good health or not, in the same way by looking at the Balance Sheet one will know the financial health of an enterprise. If the assets exceed liabilities, it is financially healthy, i.e., solvent. In the Other case, it would be insolvent, i.e., financially weak.

12.5.4 To provide accounting information to the interested parties

Apart from owner of the business enterprise, there are various parties who are interested in accounting information. These are bankers, creditors, tax authorities, prospective investors, researchers etc. Hence, one of the objectives of accounting is to make the accounting information available to these interested parties to enable them to take sound and realistic decisions. The accounting information is made available to them in the form of annual report.

12.6 ACCOUNTING PROCESS

The Accounting process consists of the following four stages :

1. Recording the Transactions
2. Classifying the Transactions
3. Summarising the Transactions
4. Analysing and Interpreting the Results.

These are discussed one by one.

12.6.1 Recording the Transactions

Accounting begins with recording or writing of all business transactions in the book of original entry called Journal. This book may be further divided into various subsidiary books such as cash book, sales book, purchase book, etc. The number of subsidiary books to be maintained depends upon the size and nature of business and the type of transactions. The business transactions are recorded in the Journal in a chronological order with the help of vouchers like cash memos, cash receipts, invoices, etc.

12.6.2 Classifying the Transactions

Classifying is the process of grouping of transactions of one nature at one place. This is done by opening accounts in a book called 'Ledger.' For example, all transactions related to cash like cash sales, cash purchase, cash expenses are posted to cash account.

The transactions pertaining to different persons are entered separately in the name of each person in a ledger. The objective of classifying the transactions in this manner is to ascertain the combined effect of all transactions taken place during a period in respect of each ledger account.

12.6.3 Summarising the Transactions

After classifying all transactions and balances, a statement called Trial Balance is prepared to adjudge the arithmetic accuracy of the books of account. If the Trial Balance tallies, it means that the transactions have been correctly recorded and posted into ledger. Then, the final accounts consisting of Profit and Loss Account shows whether the business earned profit or incurred loss during the period, usually, a year. The Balance Sheet reveals the position of assets and liabilities of the business as at the end of the year.

12.6.4. Analysing and Interpreting the Results

The last stage consists of analysing and interpreting the results shown by the Profit and Loss Account and the Balance Sheet. For this, various ratios are calculated to analyse and interpret the results. These results are used to make future plans for the business and communicated to the interested parties like management, investors, bankers, creditors, etc.

12.7 JOURNAL

Journal is a book of original entry. All day-to-day transactions of business are recorded first in it in a chronological order with the help of vouchers like cash receipts, cash memos, invoices, etc. Journal is also called a 'Day Book'. The process of recording business transactions in the journal is called 'Journalising' and the entries passed in this book are called 'Journal Entries'. The format of Journal is given below :

Journal				
Date	Particulars	L. F.	Dr. Amount	Cr. Amount
			Rs.	Rs.

The Journal consists of five columns. The first column is used for recording date of the transaction with year. In the second column i.e., 'Particulars', the journal entry is made by mentioning the two accounts affected by the transactions. The accounting entry is passed following the 'Accounting Equation' or 'Dual Aspect Concept'. The two accounts affected by the transaction are debited and credited by the same amount. The third column L.F., i.e. Ledger Folio is used for writing the page number of the ledger on which the particular account appears. The fourth and fifth columns of journal

are meant for writing respectively 'Debit' and 'Credit' amounts of the transaction.

Look at the following transactions and study how journal entries are passed for them in the Journal :

Illustration 1

Pass journal entries for the following transactions in the books of Nikhil Bhusan :

Solution :

Journal				
Date	Particulars	L. F.	Dr. Amount Rs.	Cr. Amount Rs.
1997 Jan.1	Cash Account Dr. To Capital Account (Being capital invested)		20,000	20,000
3	Bank Account Dr. To Cash Account (Being cash deposited into bank)		5,000	5,000
6	Purchase Account Dr. To Cash Account (Being goods purchased for cash.)		7,000	7,000
10	Furniture Account Dr. To Chinmoy's Account (Being furniture purchased from Chinmoy.)		5,000	5,000
11	Cash Account Dr. To Sales Account (Being goods sold to Mazumdar on cash.)		8,000	8,000
13	Ashim Das' Account Dr. To Sales Account (Being goods sold to Ashim Das.)		2,000	2,000
25	Drawings Account Dr. To Cash Account (Being cash drew for personal use)		500	500
31	Salaries Account Dr. To Cash Account (Being salaries paid.)		800	800

1997.		Rs.
Jan. 1	Commenced business with a capital	20,000
" 3	Amount deposited in S.B.I.	5,000
" 6	Goods purchased for cash	7,000
" 10	Furniture purchased from Chinmoy	5,000
" 11	Goods sold to Majumdar for cash	8,000
" 13	Goods sold to Ashim Das	2,000
" 25	Cash draw for private uses	500
" 31	Salaries paid	800

The following explanation with regard to account, the classification of accounts and the rules for debit and credit will help you understand journal in a better manner.

CHECK YOUR PROGRESS

1. Why we need of accounting

.....

.....

.....

.....

12.8 WHAT IS AN ACCOUNT?

In simple words, an account is a summarised record of all transactions relating to a particular person, a thing or an income or expense. You will know more about the ruling of an account under the next context titled Ledger 26.6. An account resembles the shape of the English alphabet 'T' as follows :

Name of the Account	
Dr.	Cr.

12.8.1 Classification or Types of Accounts

All business transactions relate to the three accounts, namely, (i) Personal Accounts, (ii) Real Accounts, and (iii) Nominal Accounts. When real and nominal accounts are taken together, these are called 'Impersonal Accounts.'

Let us have a brief discussion of each of these.

12.8.2 Personal Accounts

Accounts relating to persons and organisations representing to persons are called 'Personal Accounts.' Examples are Chinmoy's Account, Mazumdar's Account, The State Bank of India Account, Tanmoy & Sons' Account, Cachar Paper Mills' Account, Salaries Outstanding Account etc.

12.8.3 Real Accounts

Accounts which are related to properties or assets are called 'Real Accounts.' They are called Real Accounts because they represent things of value owned by the business. Cash Account, Furniture Account, Building Account etc are the popular examples of Real Accounts.

12.8.4 Nominal Accounts

Accounts relating to expenses, losses, incomes, gains, profits are called 'Nominal Accounts.' Examples of nominal accounts are Wages Account, Salaries Account, Commision Received Account, Insterest Received Account, etc.

12.8.5 Rules for Debit and Credit

The rules applicable for debiting and crediting the three types of accounts are summarised in the following Table.

Table : Rules for Debit and Credit

Accounts	Debit	Credit
Personal	Receiver	Giver
Real	What comes in	What goes out
Nominal	Expenses and Losses	Incomes and Gains

12.9 LEDGER

You have just seen that journal is just a chronological record of all business transactions. But, if we want to know the net effect of various transactions affecting an item, we need to go through the whole journal. It takes time. You know that time is money in business.

Therefore, to overcome this difficulty, we maintain another book called 'Ledger.'

Ledger is a book which contains, in a summarised and classified form, a complete record of all transactions. Since it contains complete information about various transactions, it is called the 'Principal Book'. Final accounts of a business are prepared on the basis of ledger.

You have learnt the 'T' Form of an account. The left hand side is called the debit side and the right hand side the credit side. The proper form of each account maintained in ledger is given as follows :

Specimen of Ledger Account

Ledger							
Dr.				Cr.			
Date	Particulars	F	Amount	Date	Particulars	F	Amount
			Rs.				Rs.

You will notice that both sides of ledger account have four columns, namely, date, particular, folio and amount.

12.9.1 Rules for Posting into Ledger

Posting into ledger is made from journal entries passed in the journal. It is important to mention that every journal entry will have to be posted into all accounts which have been debited and credited in the journal entry. Going back to Illustration 1, for goods purchased for cash, Purchases Account is debited and Cash Account is credited. While posting this entry into ledger, it will be posted both in Purchase Account as well as in Cash Account.

Posting will be made on debit side of the account which has been debited in the journal entry and, similarly, on credit side of the account which has been credited in the journal entry. Remember, the postings into ledger account will be made in chronological manner (date-wise).

In the particular column, the name of the account (preceded by 'To') credited in the journal entry will be written. Similarly, while posting on the credit side of the account, we shall write the name of the account (preceded by 'By') debited in the journal entry.

The amount of journal entry will be shown in the amount columns of both accounts and finally accounts will be balanced.

Let us again take Illustration 1 and study how the posting of journal entries is made in the ledger.

LEDGER

Cash Account							
Dr.				Cr.			
Date	Particulars	F	Amount	Date	Particulars	F	Amount
1997 Jan. 1	To Capital A/C		Rs. 20,000	1997 Jan. 3	By Bank A/C		Rs. 5,000
Jan. 11	" Sales A/C		8,000	Jan. 6	" Purchase A/C		7,000
				Jan. 25	" Drawings A/C		500
				Jan. 31	" Salaries A/C		800
				Jan. 31	" Balance C/d		14,700
			28,000				28,000
1997 Feb. 1	To Balance b/d		14,700				

Capital Account							
Dr.				Cr.			
Date	Particulars	F	Amount	Date	Particulars	F	Amount
1997 Jan. 31	To Balance c/d		Rs. 20,000	1997 Jan. 1	By Cash A/c		Rs. 20,000
			20,000				20,000
				1997 Feb. 1	By Balance b/d		20,000

Bank Account							
Dr.				Cr.			
Date	Particulars	F	Amount	Date	Particulars	F	Amount
1997 Jan. 3	To Cash A/c		Rs. 5,000	1997 Jan. 31	By Balance c/d		Rs. 5,000
			5,000				5,000
1997 Feb. 1	To Balance b/d		5,000				5,000

Purchase Account							
Dr.				Cr.			
Date	Particulars	F	Amount	Date	Particulars	F	Amount
1997 Jan. 6	To Cash A/c		Rs. 7,000	1997 Jan. 31	By Balance c/d		Rs. 7,000
			7,000				7,000
1997 Feb. 1	To Balance b/d		7,000				

Furniture Account							
Dr.				Cr.			
Date	Particulars	F	Amount	Date	Particulars	F	Amount
1997 Jan. 10	To Chinmoy's A/c		Rs. 5,000	1997 Jan. 31	By Balance c/d		Rs. 5,000
			5,000				5,000
1997 Feb. 1	To Balance b/d		5,000				

Chinmoy's Account							
Dr.				Cr.			
Date	Particulars	F	Amount	Date	Particulars	F	Amount
1997 Jan. 31	To Balance c/d		Rs. 5,000	1997 Jan. 10	By Balance A/c		Rs. 5,000
			5,000				5,000
				1997 Feb. 1	By Balance b/d		5,000

Sales Account							
Dr.				Cr.			
Date	Particulars	F	Amount	Date	Particulars	F	Amount
1997 Jan. 31	To Balance c/d		Rs. 10,000	1997 Jan. 11	Rs. By Cash A/c		Rs. 8,000
			10,000	" 13	" Ashim Das' A/c		2,000
				1997 Feb. 1	By Balance b/d		10,000

Ashim Das' Account							
Dr.				Cr.			
Date	Particulars	F	Amount	Date	Particulars	F	Amount
1997 Jan. 13	To Sales A/c		Rs. 2,000	1997 Jan. 31	By Balance c/d		Rs. 2,000
			2,000				2,000
1997 Feb. 1	To Balance b/d		2,000				

Salaries Account							
Dr.				Cr.			
Date	Particulars	F	Amount	Date	Particulars	F	Amount
1997 Jan. 31	To Cash A/c		Rs. 800	1997 Jan. 31	By Balance c/d		Rs. 800
			800				800
1997 Feb. 1	To Balance b/d		800				

Drawings Account							
Dr.				Cr.			
Date	Particulars	F	Amount	Date	Particulars	F	Amount
1997 Jan. 25	To Cash A/c		Rs. 500	1997 Jan. 31	By Balance c/d		Rs. 500
			500				500
1997 Feb. 1	To Balance b/d		500				

Balance in an account signifies the net result of all transactions relating to it during a given period of time. For example, the balance in personal account will indicate whether the business owes to the party or the party concerned owes to the business. The debit balance in a personal account i.e., excess of debit total over its credit total, shows that the party concerned owes to the business. On the contrary, in case of credit balance in personal account, it indicates that the business owes to the party concerned.

All real accounts relate to assets, hence, show the debit balance only.

The balance in nominal accounts indicate profit (in case of credit balance) and loss (in case of debit balance). The balance in nominal accounts are transferred to Profit and Loss Account.

12.10 TRIAL BALANCE

You have seen that for every transaction, one account is debited and some other account is credited with the same amount. In other words, for every debit, there is an equal and corresponding credit. This is the basic element of the principle of double entry system. This being precisely the case, it is but natural that the total of all the debit balances should agree with the total of the credit balances. The businessmen, periodically tabulate the debit and credit balances separately in a statement to know whether the total of debit balances agrees with the total of credit balances or not. Such a statement is called 'Trial Balance'.

If the total of debit balances agrees with the total of credit balances, it is called that the Trial Balance is tallied. It means that both the aspects of each transaction have been correctly recorded in the ledger. Remember that it is not a conclusive proof of accuracy but of arithmetic accuracy only. If the two totals do not tally, it implies that some errors have been committed here and there while posting the journal entries into ledger.

12.10.1 Methods of Preparing the Trial Balance

There are mainly two methods of preparing the Trial Balance. These are :

- (i) Totals Method, and
- (ii) Balances Method.

12.10.11 Totals Method

Under this method, the total of each side of account is shown respectively in the debit and credit columns of the Trial Balance. This type of Trial Balance is known as the 'Gross Trial Balance'.

12.10.12 Balances Method

As the name itself indicates, in this method, the balances of each account are shown in the Trial balance. The debit balance is shown in debit column and credit balance is shown in credit column of amount.

We see that the total of debit balances column in the above Trial Balance is equal to the credit balances column. This implies that the ledger has been correctly written up.

Let us prepare the Trial Balance from the ledger accounts.

Trial Balance as at 31st January 1997						
S.No.	Name of Account	L. F.	Totals Method		Balances Method	
			Dr. Rs.	Cr. Rs.	Dr. Rs.	Cr. Rs.
1.	Cash Account		28,000	13,300	14,700	-
2.	Capital Account		-	20,000	-	20,000
3.	Bank Account		5,000	-	5,000	-
4.	Purchase Account		7,000	-	7,000	-
5.	Furniture Account		5,000	-	5,000	-
6.	Chinmoy's Account		-	5,000	-	5,000
7.	Sales Account		-	10,000	-	10,000
8.	Ashim Das' Account		2,000	-	2,000	-
9.	Salaries Account		800	-	800	-
10.	Drawing Account		500	-	500	-
			48,300	48,300	35,000	35,000

12.11 FINAL ACCOUNTS

The final accounts are primarily prepared for ascertaining the operational result and the financial position of the business. These are prepared with the help of Trial Balance. The final accounts consist of the following two accounts :

1. Profit and Loss Account, and
2. Balance Sheet.

The preparation of these two accounts is discussed one by one.

12.12 PROFIT AND LOSS ACCOUNT

The Profit and Loss Account is prepared for ascertaining whether the business earned profit or incurred loss during a particular period of time called accounting period. All nominal accounts are entered into Profit and Loss Account. As a rule, all expenses and losses are shown on the debit side and all incomes and gains are shown on the credit side of the Profit and Loss Account. Then, the totals of debit side and credit side are compared for ascertaining profit or loss of the business during the accounting period. If the total of credit side exceeds the total of debit side, the excess will be profit earned during the period. On the contrary, if the total of debit side exceeds the total of credit side, the excess will be loss incurred during the period. The net result, whether profit or loss, is transferred to the Balance Sheet also called 'Position Statement.'

Taking our previous Illustration 1 here again, let us study how the Profit and Loss Account is prepared.

Remember, the first part of the Profit and Loss Account contains the Trading Account which contains information on opening stock, purchases, direct expenses and sales. There is a common practice to prepare a combined Trading and Profit & Loss Account.

Trading and Profit & Loss Account
(For the period ended on 31st January, 1997)

Dr.		Cr.	
Particulars	Amount	Particulars	Amount
	Rs.		Rs.
To Purchases	7,000	By Sales	10,000
" Salaries	800		
" Net Profit	2,200		
(Transferred to Capital A/c in the Balance Sheet)			
	10,000		10,000

12.13 BALANCE SHEET

Having ascertained the operational results, i.e., profit or loss by preparing the Profit & Loss Account, one final account still remains to be prepared is the Balance Sheet. The Balance Sheet is primarily prepared to know the financial position of the business. Hence, the Balance Sheet is also called 'Position Statement.' In other words, the Balance Sheet shows what the business owns and what it owes to others, or say, how much assets and how much liabilities it has.

As already mentioned, all nominal accounts i.e., accounts relating to expenses, losses, profits, incomes, gains, etc. are shown in the Profit and Loss Account. All remaining accounts representing personal and real accounts are shown in the Balance Sheet. The

accounts showing debit balances represent assets and the accounts showing credit balances represent liabilities. all assets and liabilities are, then, shown on their respective sides in the Balance Sheet. Like Trial Balance, the total of asset side should be equal to the total of liability side. The reason being the double entry passed for every transaction. As mentioned earlier, for every debit entry, there is an equal and corresponding credit entry and vice versa. However, if the two totals do not tally, it implies that some errors have been committed in the books of accounts. These errors need to be traced out and, then, rectified.

The preparation of the Balance Sheet is illustrated with the help of our imaginary Trial Balance given earlier.

Balance Sheet (As on 31st January, 1997)				
Liabilities		Rs.	Assets	Rs.
Capital	20,000		Cash	14,700
Add : Profit	2,200		Bank	5,000
Less : Drawing	22,200	21,700	Furniture	5,000
Chinmoy	500	5,000	Ashim Das	2,000
		26,700		26,000

Now, you have noticed that each account appearing in the Trial Balance is shown either in the Profit and Loss Account or in the Balance Sheet. As a rule, all nominal accounts appeared in the Trial Balance are shown in the Profit and Loss Account and all personal and real accounts are shown in the Balance Sheet.

12.14 ACCOUNTS FROM INCOMPLETE RECORDS

There are two systems of accounting viz., (i) The Double Entry System, and (ii) The single Entry System. The accounts discussed so far are prepared according to the Double Entry System. In case of Double Entry System, both the aspects of a transaction are recorded. For every debit, there is an equal and corresponding credit. Single Entry System actually refers to incomplete records. Under this system, for certain transactions both the aspects are recorded while for others only one aspect is recorded. Some transactions are ignored. They are not recorded at all. The Single Entry System of accounting is usually followed by small enterprises, petty shop-keepers, doctors, advocates and other professionals. The reason is that the single entry system is easy and less expensive as it does not require to employ qualified persons for maintaining accounts.

Whether an enterprise has maintained complete records of its transactions or not, it needs to ascertain profit earned or loss incurred during a period. Under the single Entry System, in the absence of complete records, profit or loss is ascertained by comparing capitals (also called net worths) at the beginning and at the end of the accounting period. The simple reason being any increase or decrease in capital of a business takes place as a result of the profit earned or the loss incurred during the year. The capitals of the business at the beginning and at end of the accounting period are ascertained by preparing Statement of Affairs at two dates. If the capital at the end is more as compared to the capital at the beginning, the difference is treated as profit earned during the period. On the contrary, if the capital at the end is less

than the capital at the beginning, the difference is treated as loss incurred by the business during the period.

Look at Illustration 2. It will help you understand how opening and closing capitals are ascertained by preparing the Statement of Affairs and then how profit or loss is ascertained.

Illustration 2

Shri Chinmoy Roy keeps his books on single entry system. His position on 31st December, 1996 was as follows :

Cash in hand Rs. 2,000; Cash at Bank Rs. 22,000; Debtors Rs. 16,500; Stock Rs. 25,000; Furniture Rs. 9,000; Expenses Outstanding Rs. 1,500.

On September 1997, he introduced Rs. 7,500 as additional capital in the business of which a machine costing Rs. 4,000 was purchased for the business. He drew Rs. 3,000 during the year.

His position on 31st December, 1997 stood as follows :

Cash in hand Rs. 3,000; Cash at Bank Rs. 31,500; Stock Rs. 28,000; Debtors Rs. 30,000; Furniture Rs. 7,000; Creditors Rs. 18,000; Prepaid Insurance Rs. 2,500.

You are required to ascertain his profit or loss for the year ending on 31st December, 1997.

Solution :

Statement of Affairs of Chinmoy Roy (As on 31st January, 1997)				
Liabilities	Rs.		Assets	Rs.
Creditors	20,000		Cash in hand	2,000
Expenses outstanding	1,500		Cash at Bank	22,000
(balancing figure)	53,000		Debtors	16,500
			Stock	25,000
			Furniture	9,000
	74,500			74,500

Statement of Affairs of Chinmoy Roy (As on 31st January, 1996)				
Liabilities	Rs.	Assets	Rs.	
Creditors	20,000	Cash in hand	3,000	
Expenses Outstanding	1,500	Cash at Bank	31,500	
(balancing figure)	53,000	Stock	28,000	
		Debtors	30,000	
		Furniture	7,000	
		Machinery	4,000	
		Prepaid insurance	2,500	
	1,06,000		1,06,000	

Statement of Profits of Chinmoy Roy (For the year ended on 31st December, 1997)	
Capital as on 31st December, 1997	Rs. 88,000
Add : Drawings	3,000
Less : Additional Capital introduced	91,000
	7,500
Less : Capital as on 31st December, 1996	83,500
Profit earned during the year	53,000
	30,500

Thus, the ascertainment of profit or loss from records can now be expressed as follows:

Profit = Capital at the end + Drawing - Additional Capital Introduced-Capital at the beginning.

If capital at the beginning is more than the capital at the end, the difference will be treated as loss.

SUMMARY

You have so far studied from the genesis of an idea to establish a small scale enterprise to its actual establishment and operation. You also know that business is undertaken mainly with profit motive. Hence, the entrepreneur now needs to know whether his/her business earned profit or incurred loss over a period of time and how is the financial position of the business. These questions are answered by accounting. The entrepreneur has to remember all transactions so as the profit earned or loss incurred the business during the period could be ascertained. This necessitates the recording of transactions taking place from time to time. The recording of business transactions in a systematic manner is the main function served by accounting.

The following are the main objectives of accounting :

To maintain full and systematic records of business transactions, To ascertain profit or loss of the business, To depict financial position of the business, To provide accounting information to the interested parties. Journal is a book of original entry. All day-to-day transactions of business are recorded first in it in a chronological order with the help of vouchers like cash receipts, cash memos, invoices, etc. Journal is also called a 'Day Book'. The process of recording business transactions in the journal is called 'Journalising' and the entries passed in this book are called 'Journal Entries'.

In simple words, an account is a summarised record of all transactions relating to a particular person, a thing or an income or expense.

Ledger is a book which contains, in a summarised and classified form, a complete record of all transactions. Since it contains complete information about various transactions, it is called the 'Principal Book'. Final accounts of a business are prepared on the basis of ledger.

The businessmen, periodically tabulate the debit and credit balances separately in a statement to know whether the total of debit balances agrees with the total of credit balances or not. Such a statement is called 'Trial Balance'. Each account appearing in the Trial Balance is shown either in the Profit and Loss Account or in the Balance Sheet. As a rule, all nominal accounts appeared in the Trial Balance are shown in the Profit and Loss Account and all personal and real accounts are shown in the Balance Sheet.

QUESTIONS

1. Explain the meaning of accounting.
2. What is the objective of accounting.
3. Explain the process of accounting.
4. What is a journal.
5. What is an account? Explain the ledges account with example.
6. In how many types accounts are classified?
7. What is trial balance? What is the use of trial balance?
8. Explain trading and profit and loss account.
9. What is balance sheet?

13. ENTREPRENEURSHIP DEVELOPMENT INSTITUTIONS

13.1 ENTREPRENEURSHIP DEVELOPMENT

13.2 DEVELOPMENT BANKS

13.3 ENTREPRENEURSHIP DEVELOPMENT INSTITUTIONS

OBJECTIVE

- AISECT model of entrepreneurship.
- Establish an EDC cell.
- Training for self employment.

ENTREPRENEURSHIP DEVELOPMENT INSTITUTIONS**13.1 ENTREPRENEURSHIP DEVELOPMENT**

Before independence there were no efforts to develop any class of entrepreneurs. Only a limited number of persons were engaged in entrepreneurial job. Rather there were some pockets where industrialisation had started and other areas were almost neglected. Govt. of India, after independence, realised that the development of such a vast country is not possible without the involvement of a large number of persons in the process of economic development. Govt. prepared various programmes for encouraging new persons to enter the field of development. Various programmes provided financial, technical, marketing inputs to potential entrepreneurs so that they could set up their enterprises in different lines and at different locations. Some institutions and agencies have been set up at central and state levels which provide every type of help to new and existing entrepreneurs. Some institutions are discussed as follows :

13.2 DEVELOPMENT BANKS

There are a number of financial institutions which help the process of entrepreneurial development. FICCI, ICICI, IDBI are operating at all India level while State Financial Corporations and State Industrial Development Corporations are helping entrepreneurs at state level. All India level institutions are taking interest for the development of entrepreneurship particularly in underdeveloped and rural areas. These institutions provide financial help to various agencies engaged in the development of entrepreneurs. These institutes also extend finances to those agencies which extend loans and other facilities to potential entrepreneurs for setting up new ventures. The institutions such as National Science and Technology Entrepreneurship Development Board of India (NSTEDB), Entrepreneurship Development Institute of India (EDII) are also providing help to institutions engaged in the development of entrepreneurs. IDBI is especially helping qualified engineers through Science and Technology Entrepreneurship Parks (STEP's). It is also operating Seed Capital Scheme for technically qualified entrepreneurs in small scale sector to meet a part of promoter's equity capital. Special concessions are given to S.C., S.T. and physically handicapped entrepreneurs. IFCI is providing risk capital assistance through Risk Capital Foundation (RCF).

State level agencies provide financial assistance to new as well as existing entrepreneurs. Some state governments have set up State Small Industries Corporations to promote small scale

entrepreneurs. States have also set up many other agencies for helping entrepreneurs in their endeavour to set up new ventures.

13.3 ENTREPRENEURSHIP DEVELOPMENT INSTITUTIONS

Arranging of finances is an important factor for encouraging potential entrepreneurs for setting up their units, but many other factors are also required to make this programme a success. There are a number of institutions which identify, train and motivate entrepreneurs to set up their own industrial units. There are many government and private institutions engaged in conducting EDP. Some of these organisations are discussed here :

13.13.1 National Institute for Entrepreneurship and Small Business Development (NIESBUD)

This institute was established in 1983 by the Ministry of Industry, Government of India. It was set up as an apex body for coordinating the activities of various institutions engaged in entrepreneur development particularly in the area of small industry and small business. The institute undertakes the following activities :

- i. Evolving effective training strategies and methodology.
- ii. Standardising model syllabi for training various target groups.
- iii. Developing training aids, manuals and tools.
- iv. Extending support to central and state agencies in executing EDP.
- v. Conducting programmes for trainees, promoters and entrepreneurs which are commonly not undertaken by other agencies.

13.13.2 Centre for Entrepreneurship Development (CED)

Gujrat Government started this centre in 1979. It is the oldest centre for EDP in India. This programme has been recognised as the most comprehensive development programme in India. It combines sophisticated entrepreneur selection techniques, development inputs, behaviour psychological training and business management counselling and culminating in the preparation of a project proposal by each trainee for his industrial unit.

Gujrat has prepared a comprehensive programme consisting of identification and training of potential entrepreneurs, post training counselling and management of financial and infrastructure facilities. The training centres under this programme have been dispersed to small towns level.

13.13.3 Entrepreneurship Development Institute of India (EDII)

EDII has been sponsored by All India Financial Institutions and the Government of Gujrat. It conducts research, training and institution building activities for encouraging the participation of backward regions and special target groups in entrepreneurship. This programme consists of the following :

- (a) Selection of potential entrepreneurs.
- (b) Achievement motivational training.

- (c) Selection of product and preparation of project report.
- (d) Business management training.
- (e) Practical training and work experience.
- (f) Post training support and follow up.

13.13.4 Technical Consultancy Organisations (TCO's)

All India Financial Institutions have set up 17 TCO's to provide industrial consultancy and training to entrepreneurs. The main functions of TCO's are :

- i. Identification of industrial potential.
- ii. Conducting pre-investment studies and preparing project report and feasibility studies.
- iii. Undertaking market research.
- iv. Undertaking techno-economic survey.
- v. Identifying potential entrepreneurs and providing them with technical and managerial assistance.

13.3.5 Xavier Institute of Social Services, Ranchi

This institute set up in 1974 has been functioning in close co-operation with an NCO called Vikas Maitri in villages of district Ranchi. This institute provides training and assists the trainees in drafting project proposals and in obtaining required finance. The programme consists of the following :

- a. Identification and selection of candidates.
- b. Motivational and managerial training.
- c. Placement and training for practical skills.
- d. Market survey and preparation of project report.
- e. Financial Assistance.
- f. Follow up and counselling.

Besides some above mentioned institutions almost all states have developed their agencies which identify the potential entrepreneurs and arrange training for them. These agencies also help entrepreneurs in raising the resources and getting other inputs. Some agencies help in marketing the products of small scale entrepreneurs.

SUMMARY

In the process of economic development Govt. prepared various programmes for encouraging new persons to enter the field of development. Various programmes provided financial, technical, marketing inputs to potential entrepreneurs so that they could set up their enterprises in different lines and at different locations.

There are a number of financial institutions which help the process of entrepreneurial development. FICCI, ICICI, IDBI are operating at all India level while State Financial Corporations and State Industrial Development Corporations are helping entrepreneurs at state level. All India level institutions are taking interest for the development of entrepreneurship particularly in underdeveloped and rural areas.

Arranging of finances is an important factor for encouraging potential entrepreneurs for setting up their units, but many other factors are also required to make this programme a success.

There are many government and private institutions engaged in conducting EDP. Some of these organisations are discussed here :

National Institute for Entrepreneurship and Small Business Development (NIESBUD), Centre for Entrepreneurship Development (CED), Entrepreneurship Development Institute of India (EDII), Technical Consultancy Organisations (TCO's), Xavier Institute of Social Services, Ranchi

QUESTIONS

1. What are the steps taken by Indian Govt. offers independence to increase the entrepreneurship.
2. How to various banks are providing help for development of entrepreneurship?
3. Name the entrepreneurship development Institutions.

14. AISECT MODEL OF ENTREPRENEURSHIP

14.1 MULTIPURPOSE ELECTRONICS & COMPUTER CENTRES

14.2 FIELD AREA SURVEY & SECONDARY DATA ANALYSIS

OBJECTIVE

After this unit you will be able to explain

- AISECT model of entrepreneurship.
- Establish an EDC cell.
- Training for self employment

AISECT MODEL OF ENTREPRENEURSHIP

14.1 MULTIPURPOSE ELECTRONICS & COMPUTER CENTRES

The Ninth plan working group on Electronics observed :

"Due to lack of proper maintenance and repair facilities the servicing of equipments is a big problem in rural areas. This is specially more important in case of medical electronics equipment and in the present context, i.t. also applies to the maintenance and repair of Computer, Communication equipment and specialised equipment required for Watershed Development. Human Resources Development in the areas of maintenance is very important. Maintenance personnel and other skilled manpower is to be ensured if Information Technology has to take roots in rural areas ".

AISECT has been experimenting on this aspect for the past ten years and has developed a model that is a positive step in the above defined direction. The model is called "MULTIPURPOSE ELECTRONICS & COMPUTER CENTRE [MEX]" , this model has been quite popular at the grassroot level and over 450 such centres have been established by AISECT , covering 29 states and providing employment to over 13500 persons.

What follows hereunder, is a brief outline of the AISECT model of MEX centres, outlining the basic perspectives, type of activities to be conducted by MEX, how to locate a centre, steps to setup, costs of the centre, its benefits and methods of multiplying such centres alongwith estimates of income & expenditure.

14.1.1 PERSPECTIVE

The perspective of the multipurpose computer and electronics centres is governed by the following key words:

True dissemination of Electrical/Electronics/Computer Technology can take place only by setting up small centres based on local needs and NOT by setting up captive units of Large Industries in rural areas for subsidy purposes.

Key word : LOCAL NEED BASED

A single activity like `production' may not render a Centre economically viable in rural areas. Therefore the centres have to be multipurpose `Training cum Servicing' and if required `Production' alongwith i.t., will be their basic mode of operation.

Key word : MULTIPURPOSE

Starting with Training has several advantages. I.t. generates awareness about the centre and about the technology in the field area, increases receptivity of both in the area and makes the centre self sustaining from the very beginning. Training can be a starting point. From there we can proceed to servicing and then to localised Production.

Key word : START WITH TRAINING

The centre has to link up effectively with rural institutions, specially with schools and colleges, Gramin banks, Development Departments, Panchayats and Health centres on one hand and with Resource Persons and Resource Institutions on the other.

Key word : EFFECTIVE INTERLINKAGE

The centre should be innovative in its choice of courses, training methodology, Production and marketing, networking and even in selection of activity for the area.

Key word : INNOVATIVE

The centre should be able to respond to dynamic situations capable of transcending into the next stage of operation. Thus in due course of time i.t. may also take up interventions in other Rural Development Areas.

Key word : STRATEGIC AND RESPONSIVE

14.1.2 Choice of Activities

A. TRAINING	B. SERVICING	C. PRODUCTION / SERVICES	D. OTHERS
<p>A.1 General :</p> <ul style="list-style-type: none"> • House wiring • Motor winding • Repair of domestic appliances. • Repair of audio equipment. • Repair of video equipment. • Pumps and motors. Data Processing • Computer applications. • Other short term and long term tailor made programmes. <p>A.2 Institutional :</p> <ul style="list-style-type: none"> • Computer Literacy in Schools. • Training under TRYSEM. • Training of SC/ST candidates under departmental schemes. • Training of bank employees. • Training of Panchayats and elected bodies. • Training of women under specified programmes. 	<ul style="list-style-type: none"> • Household electric wiring. Motors and Pumps. • Household electrical appliances. • Tape recorders, audio amplifiers etc. • Portable T.V., Colour T.V. and other video equipment. • Transistors and radios. • Boosters, antennae, Cable T.V. • Battery chargers and Communication equipment. • Other electrical, electronics and computer hardware related equipment. 	<ul style="list-style-type: none"> • Power supply items like chokes, transformers, coils, stabilisers and eliminators • entertainment electronic items like audio amplifiers, tape recorders, decks • Services in the area of word Processing, data processing for banks, land records etc. • school results processing • DTP and screen printing • Sponsored projects for local institutions 	<ul style="list-style-type: none"> • Software Development. • Hardware maintenance. • Communication centres. • Consultancy and support. • Artisanal development. • Application of electronics and I.T. in newer areas. • Popularisation of science.

Demands at the field area being are essentially multipurpose, the MEX centres do not concentrate on a single type of activity only. Based on the demands the following activities are possible at a MEX centre

- A. Training
- B. Servicing
- C. PRODUCTION / SERVICES
- D. Others.

14.1.3 Field Area Identification

Each **MEX** centre works on a typical field area of about 100sq.kms. with typical population cover of 1.5 - 2.0 lacs. The block headquarters acts as a nodal point, below which "B" (big village) level services can be promoted. The field area identification is based on the **N** (nodal point) **B** (big village) **M** (middle village) **S** (small village) **approach**. A sample field area based on this approach will be as follows.

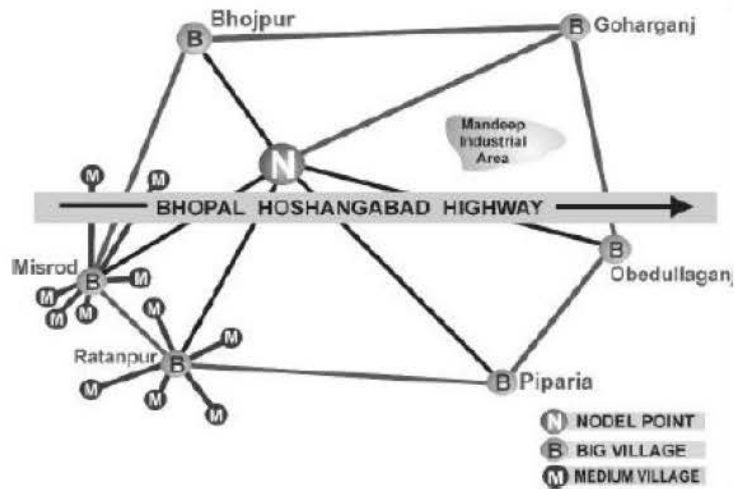

Fig. 5.1

14.1.4 Steps to set up a centre

The **MEX** centres are set up in the following stages

- Preliminary survey, secondary data analysis, census data and maps.
- Selection of Nodal Point.
- Choice of field area.
- Procurement and installation of equipment.
- Starting first batch of training after field area campaign..
- Household survey and Market Survey.
- Starting servicing.
- Starting production.
- Diversification into other areas and institutional activities.

14.1.5 Costs of a centre

The **MEX** centres will be setup on the following costs

a. Fixed costs

- i. Computer Lab : 1,25,000/-
- ii. Electronics Lab &

	Electrical Lab	:	22,500/-
iii.	Furniture	:	20,000/-
	TOTAL	:	1,67,500/-
b. Recurring Costs			
i.	Salaries	:	70,200/-
ii.	Rent	:	18,000/-
iii.	Material & Consumables	:	36,000/-
	TOTAL	:	1,67,500/-
	GRAND TOTAL (a+b)	:	2,91,700/-
	Approx 3,00,000 : 00		

14.1.6 Benefits of a centre

The benefits of a **MEX** centre can be enumerated as follows :

- Employment : 4-5 persons
- Yearly ploughback : 30,000 to 90,000
- Creation of facilities for training , servicing and production with consequent social benefits
- Regular training to over 40-50 youth
- Possibilities of intervention in newer areas like communications

14.1.7 Methods Adopted in Multiplication of such Centres

1. Rural Electronics Entrepreneurship Development Workshops.
2. Motivational Campaign with existing faculty and students within AISECT.
3. Support from State Electronics Development Corporations.
4. Through open advertisements.
5. Induction effect in adjoining areas.
6. Approaching existing non-functional setups in smaller places.
7. Through KVIB sponsored workshops.

14.2 FIELD AREA SURVEY AND SECONDARY DATA ANALYSIS

14.2.1 Why survey and action plan ?

A multipurpose electronics and computer centre is set up based on local demand. It is therefore necessary to identify the types of courses required in the field area, the employment potential, the available physical and manpower resources in the field and industrial and educational background of the selected block /

district. The Survey is conducted to affect this identification. The Survey also helps in identification of services and production related demands in the field. The action plan is made to link up the demands with the facilities and resources available / sought to be created, through the MLCC.

14.2.2 Objectives of the survey

The following are the main objectives of the survey :

- i. To identify the Geographical resources of the block.
- ii. To list the educational institutions of the block.
- iii. To find out the status of developmental programmes being run in the block.
- iv. To identify the physical and human resources of the block.
- v. To identify the possibilities of creating I.T. related services to improve the Quality of life of the people in the area.
- vi. To list out possibilities of servicing of various electrical & electronics / communication / computer related equipment and to identify difficulties in servicing faced by people.
- vii. To identify demands for training in new vocations.
- viii. To identify nodal points in a block where a centre can be located.
- ix. To identify possibilities of tiny scale production / services from the proposed MLCC.

14.2.3 How to conduct the survey?

The survey is conducted in two parts. They are:

- (i) Collection of secondary data.
- (ii) Sample survey of over 100 families in the field area.

The secondary data can be collected from various published sources. The family survey can be conducted through the students or NGO members based on a questionnaire

The procedure for conducting the survey is described in the table below.

Table : How to conduct Survey

Sr.N o.	Target	Sources	What to Do?	Required Conclusions
1.	Identification of the block	<ul style="list-style-type: none"> - Data from Block Development Office - District census Handbook - District Statistical Handbook - NIC office - Block Panchayat Office - Primary Level Geography book 	<ul style="list-style-type: none"> - Prepare the list of Panchayat and villages in the block - Identify bigger Panchayats and markets as nodal points - Identify major vocations in the block - Prepare a map showing location of MLCC 	<ul style="list-style-type: none"> i List of Panchayats and villages with artisanal concentration, demographic details ii List of bigger Panchayats where nodal points can be created iii List of proposed vocations iv Map of the block
2.	Identification of Educational Institutions in the block	<ul style="list-style-type: none"> - Data from Block Education Officer (BEO) - Senior Principals, Principals of Central Schools. - Block Development Officer - Tribal Development Officer - Own sources 	<ul style="list-style-type: none"> - Prepare the List of Primary, Middle and High / Higher Secondary Schools, Colleges in the block - Prepare the List of Technical Institutions (I.T.I., Polytechnic, Engineering) - Prepare a list of major private / NGO sector institutions - Consider possibilities of training in these institutions, specially Schools 	<ul style="list-style-type: none"> i Preparation of a list of educational institutions in the field area. ii Identification of private and government institutions separately iii. Finding of possibilities of giving support to these institutions in I.T. / interlinking with them
3.	Identifying developmental schemes being run in the block	<ul style="list-style-type: none"> - Block Development officer (BDO) - Block Education Officer (BEO) - Health Department - Tribal welfare Department - Women and Child welfare Department - Department of Rural Development - Block Panchayat Officer - NGO's - Published Data 	<ul style="list-style-type: none"> - Prepare a list of developmental programmes in the state - Identify the potential of I.T. applications in these programmes and the support that the MLCC can provide 	<ul style="list-style-type: none"> i. List of developmental Programmes, department wise ii. List of possible applications in Electronics and I.T.
4.	Identifying physical and human resources of the block	<ul style="list-style-type: none"> - District statistical handbook - District census Handbook - Resource persons available in the block - Visit to the markets and major technical institutions - BDO office - Primary level Geography book - Other published data 	<ul style="list-style-type: none"> - Prepare a list of major physical resources (minerals, Crops, forest produce and live stock) - Prepare a list of major industries and vocations - Prepare a list of resource persons - List of other NGO's, what are their activities 	<ul style="list-style-type: none"> i. List of resources like minerals, Crops, Live stock, forest produce ii. List of major industries and vocations in the block iii. List of resource persons with addresses iv. List of other institutions INGO's in the field v. List of computer / Electronics based institutions
5.	Identification of possibilities in Quality of life	<ul style="list-style-type: none"> - Structured discussion with over 100 families in the block head quarter and five selected panchayats 	<p>Discuss with people of various social strata and ask them what is the major problem which they think can be solved with an I.T. related (MLCC type) input. Explain to them the possible inputs</p>	<p>Suggestions about major problems to be tackled</p>
6.	Identification of difficulties in servicing of equipment	<ul style="list-style-type: none"> - Discussion with the following in the block head quarter and five selected panchayats - Artisans and shopkeepers - Extension officer - A few representatives from the public. - Cross section of people - Institutional heads (Schools, Hospitals, industries) 	<p>Based on the discussions and with your own estimate, list of the difficulties in servicing of various Electrical / Electronics / I.T. equipment; consider how we can solve them</p>	<p>List of difficulties in servicing of equipment List of possible suggestions</p>

7.	Identification of vocational training required in the block	Information obtained from the above (6) sources	Based on the conclusions of the above (6) points, prepare a list of new vocations requiring training.	List of new vocations requiring training. List of courses to be run on priority
8.	Identification of possibilities of servicing of equipment	Information obtained from the above (6) sources	Based on the information obtained through points (1-6) above. Prepare a list of equipment / area requiring servicing facilities.	List of equipment / area requiring servicing facilities
9.	Indetification of Nodal points within the block	Information Obtained from points (1-8)	Identifying nodal points based on the conclusions of points (1-8) above.	Prepare a List of nodal points within the block where a MLCC can be set up.
10.	Possibilities of production	Information Obtained from points (1-9).	Prepare list of products / services required in the block, that can be attempted in the MLCC.	List of products / services required in the block.

14.2.4 Action Plan Format

1. General information

- 1.1 Name of the Block :
- 1.2 Name of the District :
- 1.3 No. of Panchayats in the Block :
- 1.4 Total Population :
- 1.5 Per Capita income :
- 1.6 Name of the Survey :
- 1.7 Name of the NGO :

2. List of Educational and Technical Institutions (Prepare detailed list)

No.	Category	Total no. of Students	Place/ Location
	Technical Institutions i. Engineering College ii. Medical College iii. Polytechnic iv. I.T.I.		
	College / Schools i. Primary ii. Middle iii. High School iv. Higher Secondary Schools v. Colleges		
	Public Sector / Private Sector organisation		

3. List of Developmental Programmes

Name of the department	Name of the Project	How can you interlink?

4. Physical Resources

No.	Category	Resource
	Mineral	
	Crops	
	Forest Produce	
	Others	

5. Major Industries

No.	Major Industrial Area	Major Industries

Human Resources :

List of Resource Persons Identified

No.	Name and Address	Area of work

List of institutions in Electronics / Computers / I.T.

No.	Name of the institution	Full Address	Functional from (date)

6. Suggestions Regarding Improvement in Quality of
life through I.T.:

1. -----
2. -----
3. -----
4. -----
5. -----

7. Difficulties in servicing of Equipment :

1. -----
2. -----
3. -----
4. -----
5. -----

8. List of possible Vocations / Courses for Training :

1. -----
2. -----
3. -----
4. -----
5. -----

15. HOW TO SET UP AN AISECT CENTRE

15.1 OPPORTUNITIES IN IT & ITES

15.2 ABOUT AISECT

15.3 HOW TO SET-UP AN AISECT CENTRE

OBJECTIVE

After this unit you will be able to explain

- Know about AISECT
- Courses run by AISECT
- How to set up AISECT Centre

HOW TO SET UP AN AISECT CENTRE

15.1 OPPORTUNITIES IN IT AND ITES

In the present scenario of Information Technology, there are tremendous opportunities in the field of IT and IT enabled services. The opportunities of self-employment in various sectors of IT are constantly increasing due to expansion of IT in the country and involvement of private participation in this field. Not only in big cities but the use of IT is increasing in the districts, blocks and even Panchayat level also. The Govt. of India has planned to establish a knowledge centre or information kiosk in all the 2.5 lakh Panchayats. The private sector is also disseminating Information Technology upto Blocks and Panchayats level by providing various types of IT services. Looking at all these advancements the opportunities of self-employment is in huge demand in the field of Information Technology. After completion of your education if you are an enterprising person and wish to do something in the field of IT, then setting-up an AISECT centre is one of the best options to start with.

15.2 ABOUT AISECT

The All India Society for Electronics & Computer Technology is a leading Education and Development network of India, having over 4500 affiliated centres essentially engaged in training, servicing and info services, specially in the field of Computers and Electronics. The organisation has its spread in 29 states of the country including Madhya Pradesh, Chhattisgarh, Orissa, Uttar Pradesh, Maharashtra, Rajasthan, Tamil Nadu, Kerala, Gujrat, Jharkhand, West Bengal, Bihar, Haryana, Pondicherry, Manipur, Andhra Pradesh, Uttaranchal, Delhi, Punjab, Jammu and Kashmir, Himachal Pradesh, Sikkim, Andaman Nikobar, Nagaland, Karnataka, Tripura, Meghalaya, Assam and Chandigarh..The uniqueness of the organisation lies in its reach to the grassroots level including sub-block and panchayat levels.

AISECT's basic objective is spread of Technical and Vocational education, specially in IT related areas, Electronics and Electrical fields, in a manner so as to be easily available to all sections of the Society.

The main motto of the organisation is 'I.T. FOR EDUCATION & DEVELOPMENT'. AISECT has a special course material cell that constantly works to improve and upgrade study material and to

bring out new material specially in local languages. The Organisation has set up a Centre for Entrepreneurship Development and an e-Learning Centre. AISECT has now made a Plan for setting up 50,000 one machine centres all over the country.

15.2.1 The Courses run by AISECT

AISECT conducts training programmes in various fields. The details are as under:

1. Computer Software Training Programme
2. Computer Hardware Training Programme
3. Vocational Training Programme
4. On-line Training Programme
5. Computer Training Programme for Schools

These training programmes are successfully conducted since last two decades by the AISECT centers. These centers are named as under:

1. Computer Software Centre
2. Computer Hardware Centre
3. Vocational Centre
4. E-gyan Centre
5. Children's Computer Academy (CCA)

6.2 How to set-up an AISECT centre?

If you wish to start your own business in the field of Information Technology then setting-up an AISECT centre is one of the best options to start with. The important steps to start an AISECT centre are as follows:

1. As first step you have to give an application to set-up a centre to "Director AISECT" on a plain paper. For establishing a centre with prospective location of the centre.
2. The AISECT Head office has made a affiliation offer for setting-up an AISECT centre. This offer is made available on our website www.aisect.org
3. An affiliation fees has to be deposited in AISECT Head office for setting-up an AISECT centre. The fees is different for different types of centers and categories of the centers. The details of fees are available in the relevant affiliation offer.
4. If you agree with all the terms and conditions defined in the Affiliation offer then fill up the attached Datasheet at the end of the offer document and send it to AISECT Head office. Along with this datasheet, you have to send the DD of Affiliation fees also.
5. As soon as the Head office receives your datasheet and affiliation fees, we send our agreement to you for signature. There after we provide you the Affiliation certificate and the kit to start your centre. You are then authorized to start an AISECT centre.
6. Along with these procedure you have to identify the premises and purchase the equipments to set up the centre. The premier when you complete the above requirements, the Development Officer of AISECT would visit your centre for inspection.

7. After the inspection you can start admitting the students in your centre.

By the above procedure you can set-up an AISECT centre.

The essential cost estimation for setting-up the centre: To establish an AISECT centre at a Panchayat, Block, District or big cities the cost of infrastructure are different as per the requirement of the particular area. On this basis an approximate investment of Rs. 50,000/- to Rs. 5,00,000/- is required to setup a centre at various locations. For further details you have to contact the AISECT Head office.

15.3 HOW TO SET UP ON AISECT CENTRE

The entrepreneurs are provided support at various levels for setting-up and running successfully their centre by the AISECT Head office. The important supports are as mentioned below:

1. AISECT will provide technical help and advice the entrepreneurs for getting financial support.
2. AISECT has prepared the course material for software, hardware and vocational courses as per the demand of the market. These course materials are made in Hindi and English languages.
3. AISECT provides centralised advertisements along with the publicity material for the publicity of its courses.
4. AISECT takes up various projects through its network and for any kind of problem, our District Coordinator and Development Officers are there to help you.
5. The National Centre established by AISECT with the support of Department of Science and Technology, Govt. of India, conducts examinations for its students and provide them certificates and diplomas.

Thus support is provided at each step to you by AISECT.

As per the present scenario of Information Technology in India, starting your own business in this field is a far-reaching decision. By doing so, you can also contribute to the use and development of Information Technology in your region and act as an important factor while earning your own livelihood. Along with these you can also provide employment to others in your centre.

Education is the first step. You can make a golden future with AISECT.

SUMMARY

As the opportunities in IT and ITES are increasing day by day giving opportunity for self employment. Govt. as well as private sectors are showing immense interest in IT and ITES. After completing education you can set on AISECT centre to become an entrepreneur in the field of IT. AISECT is the national organisation having presence in all over India. The AISECT runs computer software, hardware and many other like vocational training program. One start an AISECT centre to grow and become a succesful entrepreneur in field of IT.

16. TRAINING FOR SELF EMPLOYMENT

16.1 TRAINING FOR SELF EMPLOYMENT

16.2 SELF EMPLOYMENT SCHEMES

OBJECTIVE

- After this unit you will be able to explain
- Swaran jayanti rojgar yojna for urban youth
- Swaran jayanti gram swarojar yojna
- Antyavasayi scheme for SC /ST youth
- Easy loan scheme to educated unemployed youth
- Women power stri shakti scheme

TRAINING FOR SELF EMPLOYMENT

16.1 TRAINING FOR SELF EMPLOYMENT

Looking at the limited availability of employment opportunities in Government and semi government sectors, and also seeing the benefit a self enterprise would give, but interested individuals fail to do so, due to lack of resources. In order to train and provide financial assistance to resources lacking individuals, various departments / institutions has launched various profiting schemes. Few of the major schemes cordinated by specific departments / institutions are mentioned below :

1. Swaran Jayanti Rojgar Yojna for urban youth.
2. Swarn Jayanti Gram Swarojar Yojna.
3. Antyavasayi Scheme for SC / ST youth.
4. Rashtriya Safai Kamgar (Scavengers) Mukti and Punarvas Yojna (Pratishtha Yojna)
5. Video Camera Unit Scheme of Antyavasayi Sahakari Sanstha Maryadit.
6. Easy loan scheme to educated unemployed youth.
7. Women Power `Stri Shakti' Scheme.

16.2 SELF EMPLOYMENT SCHEMES

16.2.1 Swarn Jayanti Rojgar Yojna

The Swarn Jayanti Rojgar Scheme was announced by the Government of India on 11 Oct. 1989, with a view to provide employment opportunities to urban unemployed and partially employed individuals.

But this program was first implemented in the year 1990-91. This scheme is prevalent in those urban / sub urban sectors whose population according to the 1981 census is more than 10,000. and where any I.R.D.P. scheme is not running. This scheme is coordinated from local agencies / Nagar Nigam (Local urban Bodies) and district Urban Development Corporation from 1/04/99 this scheme has been rechristened as Swarn Jayanti Rojgar Scheme.

a) Eligibility to avail this schemes

Those individuals can benefit from this scheme who :

- Are residents of the related area for the past 3 years.
- The annual family income of the applicant must not be more than Rs. 11,850/- per annum.
- The applicant should be between 18-45 years of age.
- The applicant's name must be registered / included in the ration card.
- The applicant should have technical knowledge about the work for which he/she wishes to avail loan.
- The applicant, at the time of applying, must not be enjoying any Government sponsored scheme from other Banks / Financial institutions.

b) **Assistance provided under this scheme.**

There are two kinds of assistance falling under this scheme - in the form of loan and in grant. The amount would be as follows :

Category of Beneficiaries	Loan Amount	Limit of Amount. of Grant
SC/ST/Women	15,000/-	5,000/-
Others	12,000/-	4,000/-

The repayment of loans under this scheme can be done on a monthly basis period or once in three months within 5 months.

c) **The Margin Money/Guarantee invested by the Beneficiary.**

The loans, advanced under this scheme, do not require any margin money from the banks. The assets of the individuals are kept in mortgage by the banks in lieu of the loan, as guarantee.

d) **Interest Rate /rate of Interest**

The rate of interest on the loans advanced under this scheme is subjected to the rate of interest fixed by the RBI from time to time .

16.2.2 Swarna Jayanti Gram Swarojgar Yojna

In place of the various self employment schemes run at rural sectors like DYSEN, IRDP,DWCRA, SITRA, GKY and MMS, a new scheme called SJGSY was launched from 1/04/99. This scheme would benefit families who fall below the poverty line. The list of Beneficiaries, is passed at the Gram Sabha. It is however necessary that the list of beneficiaries must include atleast 50% SC/ST, 40% Women and 3% Physically Challenged.

Under this scheme the amount of grant is 30% of the total project cost or a maximum of Rs. 7,500/- and 50% of the total project cost or a maximum of Rs 10,000/- in case of SC/ST's.

Under this scheme, there is also provision for coordinating training programs aimed at providing technical expertise to the beneficiaries.

16.2.3 Antyavasayi Scheme

This scheme was launched in 1976. The main objective of this scheme is to assist beneficiaries of SC/ST categories, whose annual income is less than Rs. 1,10,000/- and who are a member of the Antyavasayi Sahakari Sansthan Maryadit to help set up self enterprises by helping in getting loans from the banks to improve their economic state.

Under this scheme, there are many ongoing activities which are aimed at improving the financial state of many beneficiaries like setting up of agriculture, small scale horticulture, irrigation, Dairy, Transportation, Business, enterprise and rural and cottage industries.

Alongwith this, in order to encourage employment and self employment opportunities many other schemes are run by the Antyavasayi Sahakari Sansthan Maryadit, like - Vasundhara Yojna, New Jeevan Aavas Yojna, Swavlamban Yojna, Pavan Putra Yojna, Madhuban Yojna, Nyaya Niketan Yojna, Sahakar Yojna, Raftar Yojna, Vanaja Yojana, etc.

To know/ benefit from any of these schemes interested SC/ST youth can contact the District Antyavasayi Sahakari Samiti Maryadit's office in the concerned district.

16.2.4 Pratishtha Yojna

This scheme is to help the individuals presently involved in demeaning jobs to free them and give them the choice of alternative occupation. This scheme has two perspectives -

- a) Training
- b) Financial assistance.

During the training, the scavengers are oriented with technical knowledge trained in vocations like Screen Printing, Typing, Driving, Sewing, Knitting etc. There is a provision of charging Rs 500/- per beneficiary for this training out of which the institute is paid Rs 350 as the training fee and Rs 150 /- per month is paid as scholarship to each trainee.

Under this scheme, there is a provision of providing financial assistance to these scavengers for self employment and other alternative occupation. According to the scheme, a total of Rs. 20,000/- is made available to the beneficiaries for self employment ventures, out of which Rs 10,000/- is the Bank loan and Rs 10,000/- is in the form of grants.

Those individuals interested in the Pratishtha Yojna can contact the Antyavasayi Sahakari Sansthan Maryadit's office, working in the concerned district.

16.2.5 Scheme for Financial Assistance in setting up Video camera Unit for the youth belonging to SC/ST category

In order to provide assistance in setting up self employment ventures to youth of SC/ST category, the Antyavasayi Sahakari Sansthan Maryadit, has proposed financial assistance for procuring video cameras. The following is the break up of Financial assistance for setting up the Video camera unit, under this scheme -

In Rs.		
a	Video camera, Battery Adapter and Accessories	30,000
b	Video Light/ Lense filter etc	2,000
c	Colour T.V. with V.C.R	32,000
d	Junction box, Kit box	1,100
e	Tape Recorder	6,900
f	Rent In advance	5,000
	Total Cost	77,000

Under the above mentioned scheme, the beneficiary is expected to invest about 5% Margin money and a maximum of Rs. 6000/- is provided as grant by the Committee.

The eligible SC/ST youth in order to benefit from this scheme must be -

- 18 -45 years of age.
- Original resident of Madhya Pradesh
- Whose annual family income is less than Rs. 22,000/- and
- Enrolled in the Employment exchange for the past 2 years.

For the above scheme (Video Camera Unit), applications are invited by the District Antyavasayi Sahakari Sansthan Maryadit of the concerned district from time to time (whenever this scheme is applicable in concerned districts). Hence interested individuals may contact the office of the District Antyavasayi Sahakari Sansthan Maryadit.

16.2.6 Soft loan scheme for educated unemployed youth

Whenever an individual is advanced a loan by any Financial institution, the concerned individual is expected to deposit margin money (excluding some specific schemes). The schemes might differ from one financial institution to other and mostly the cost of unit might range from 5 - 50%. Because most of the first generation of educated unemployed youth's financial sources are not sound and hence cannot arrange the margin money expected by the Financial institutions, therefore for such educated unemployed individuals who are otherwise capable of setting up any unit and the only hitch is in arranging the margin money, the Manpower Resources Management Department has initiated a Soft loan scheme.

a) Format of the Assistance provided under this scheme

The assistance under this scheme is in the form of margin money. The project cost of any unit can be divided into 7 categories-

1. Cost of Land.
2. Cost of Building/Shed.
3. Cost of Plant & Machinery.
4. Pre-operative expences.
5. Cost of various fixed/tangible assets.
6. Contingency expences and
7. Working Capital.

Out of these the first six issues are related to capital investment expenses whereas the seventh issue is the working capital expence. Under this scheme 10% of Fixed Capital Investment (maximum of Rs. 50,000/- in case of Propriety units and Rs. 75,000 incase of Partnership units) is provided as soft loans.

b) Eligibility of availing assistance under this scheme

Under the Soft loan scheme, those educated unemployed youth are eligible who -

- Is a board or high school passed or ITI passed. Incase of SC/ST application, the minimum qualification is eighth standard passed.
- Applicant must be a original resident of Madhya Pradesh.
- The age of the applicant must fall between 18 - 40 years
- The applicant should be an unemployed i.e. his/her name should be enrolled in the District Employment Exchange.
- The proposed project cost of the applicant must not exceed Rs.7.5 lakhs.
- The applicant's loan requisition form must have been accepted by any bank or Financial institution.

The assistance, under this scheme can be about 10% of the cost of Fixed assets of the project, incase of Propriety units, it is a maximum of Rs.50,000/- and incase of partnership units a maximum of Rs. 75,000/- is allowed. Incase of SC/ST and Physically Handicapped entrepreneurs, the soft loan is the 25% of their project cost.

c) Interest on the Soft Loan

The rate of interest on the soft loan depends on the amount of the soft loan. In this context, a 4% on loan amount upto Rs. 25,000/-, a 6% on loan of Rs.25,000/- - Rs. 50,000/- and a 8% rate of interest on amount exceeding Rs.50,000/-.

d) Why is this loan a 'Soft Loan'?

Under this scheme, the Soft loan helps in the form of margin money when the Entrepreneur is unable to arrange it from any of his sources. This loan is called as 'Soft Loan' because it is easily accessible/available to those individuals/applicants whose application for Self enterprise

has already been accepted by some banks/ financial institutions. Secondly, the rate of interest on these loans is less. Thirdly, the repayment of these soft loans can be done, once the maximum loan is repayed to the bank. Finally, the documents/enclosures required for applying for such loans is the same which was presented for applying for loan from the banks/financial institutions by the Entrepreneur.

In this way, the entrepreneur can invest some money in addition to the soft loan recieved and present it as the margin money. For eg, if the project cost of an Entrepreneur is 7 lakhs, out of which 5 lakhs is of the fixed assets. Therefore 25% or Rs. 1.75 lakhs is expected as margin money from the Entrepreneur. In this condition, the Entrepreneur can invest Rs. 1.25 lakhs and for the rest Rs. 50,000 can apply for a soft loan.

e) *Whom to contact under the Soft Loan scheme?*

Under the above mentioned scheme interested youth for obtaining soft loans can contact the DIC of the concerned district.

Similarly to provide assistance to unemployed youth for setting up of self enterprises, there are many schemes launched by different departments and institutions that gives soft loans, grants and other loans.

16.2.7 'Stri Shakti' Scheme

The Banks, on the occassion of Women's Day had on 19th Nov 1988, launched a scheme called 'Stri Shakti' under the Women's Entrepreneurship Development, to provide loans to women Entrepreneurs for setting up their enterprise. The interested women were informed of many exemptions and provisions of facilitating margin money at a lesser rate of interest.

The small industries development Commissioner, had introduced and defined a Women Entrepreneur as follows -

"Any small enterprise/ enterprise related services or business enterprise, business which is coordinated by one or more than one women Entrepreneurs and those private limited companies/ cooperative committees whose trustees, shareholders/Directors have not less than 51% Share Capital."

The Stri Shakti package is based mainly on the following training program -

1. Entrepreneur Development Programme (EDP)
2. Entrepreneurship Education Programme (EEPMA)
3. Awareness program for Self Employment activities

(APSA)

Technically and economically sound all the above cases/applicants must be dealt with as soon as possible, even if the applicant has not participated in the specific training. It is not necessary to attend training programs to get benefits from this package, the training programs inform the new entrepreneur regarding the problems that

might crop up, related to their enterprise and how to effectively solve it. These kinds of training programs instigate confidence in all types of Entrepreneurs.

The experienced employees of the bank provide important information and services to those Entrepreneurs also, who wish to work from home and setup any unit. A lot of changes have been made in this package.

a) Margin

The Stri Shakti package provides 5% reduction on the general margin for enterprise loan of upto Rs. 25,000 /- except under the Entrepreneur Scheme where this rebate/exemption is for over 5 - 10 lakhs of project.

b) Interest Rate

- There is no exemption in interest for those small enterprises whose amount falls between the range of Rs. 25,000/- to Rs. 2 lakhs.
- For Rs. 2 lakhs - Rs. 50 lakhs loan of small enterprise, a 0.5 % exemption in the present interest rate is given.
- The loan advanced under the Stri Shakti package in which the small enterprise does not exceed a 2 lakhs, an exemption of 0.5% in the current interest rate.
- Under the Stri Shakti package, the women Entrepreneurs whose enterprise is over 2 lakhs, a 0.5% discount in current interest rate is given.
- For Women Entrepreneurs involved in Private Retailing business, there is no exemption under the Stri Shakti package.

c) Loan facilities provided

The list of loan facilities provided to Women Entrepreneurs is given below -

i. Occupation and Self Enterprise

Under this, all those women, like being a Chartered Accountant runs her own business. This includes Advocates, Doctors, Architects, Interior decorators, Photographers, Commercial artists, Coaching classes, Type writing/Education business is considered as a business or self enterprise.

ii. Women engaged in Women based vocations

All those women Entrepreneurs engaged in Beauty Parlours or Laundry, Tea stall, Boutiques, Library, Tailoring, Rope making through Sewing Machines, Home delivery service, Creche etc., also fall under this category.

iii. Wholesale business

General stores, Cutlery shops, Handicrafts, Pickles, Cold Drinks and Cigarettes etc.

iv. Rural and Cottage Industries and Small Enterprise

Under this, Handloom button, Handicraft, Food Processing Units, Beauty products, Pottery, Garment manufacturing or other such units are included.

v. Agriculture related activities

Activities related to agriculture like - Poultry farm, Cattle rearing (Dairying), Rabbit Rearing, Horticulture related Nurseries etc fall in this category.

The Women Entrepreneurs can not only benefit from these above mentioned schemes but through depositing their money in these banks can help and support other women Entrepreneurs in establishing their units.
